

2021

# Amendment No. 1

North End Urban Plan

*Adopted February 10, 2021*

2017 COMPREHENSIVE PLAN





STATE OF RHODE ISLAND



Department of Administration  
**DIVISION OF STATEWIDE PLANNING**  
235 Promenade Street, Suite 230  
Providence, RI 02908

Office: (401) 222-7901  
Fax: (401) 222-2083

April 16, 2021

Jeanne-Marie Napolitano  
Newport City Hall  
43 Broadway  
Newport, RI 02840

Subject: State Review of Comprehensive Plan Amendment

Dear Mayor Napolitano:

This correspondence presents the results of my review of the Amendment titled *Newport North End Urban Plan* to the City of Newport's Comprehensive Plan. The Comprehensive Planning and Land Use Regulation Act (the Act) requires that I review municipal comprehensive plans to ensure that comprehensive plans and subsequent amendments comply with the requirements listed in §45-22.2-9(d). Therefore, pursuant to these requirements, I hereby find:

- 1) the intent and goals of the Act, as stated in § 45-22.2-3(b)(1) and (c)(1) through (10), have been met;
- 2) the Plan as amended is internally consistent and complete as required by § 45-22.2-6;
- 3) the Amendment is consistent with, and embodies, the goals and policies of the State and its departments and agencies as contained in the State Guide Plan and the laws of the State;
- 4) municipal planning activities have been coordinated according to the provisions of § 45-22.2-7;
- 5) the Amendment has been officially adopted and submitted for review in accordance with § 45-22.2-8 and other applicable procedures;
- 6) the Amendment complies with the rules and regulations adopted by the State Planning Council; and, that
- 7) adequate, uniform, and valid data have been used in preparing the plan or amendment.

**Decision**

Based on these findings, I certify that the *Newport North End Urban Plan* Amendment is consistent with the goals, findings, and intent as established by the Act.

Congratulations and on behalf of the State of Rhode Island, we look forward to working with your community in realizing the desired future as expressed by the residents of Newport through your Comprehensive Plan.

Yours truly,

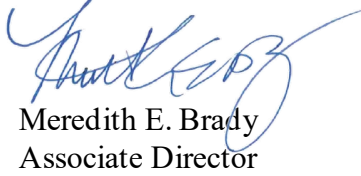
A handwritten signature in blue ink, appearing to read "Meredith E. Brady".

Meredith E. Brady  
Associate Director

cc: Patricia Reynolds

1. Location: **Chapter 3 - Land Use**  
Page 3-0 (new page)

*Description of amendment: The North End Commercial neighborhood area has the largest geographic area of commercial land in the city, and is considered to be underutilized, given intense development and natural resource protection in other areas of the city. The current commercial uses in this neighborhood are predominantly big box stores and the former jai alai site, surrounded by large expanses of impervious area. The current development pattern is contrary to Newport's dense, pedestrian-friendly urban core. This 2017 Comprehensive Plan calls for the development of this area as a mixed-use innovation hub. With the design of proposed Pell bridge ramp realignment project underway, and the potential for additional development area in the North End, the City recognized the need to more clearly define the vision, and undertook a planning effort to develop an area plan for the entire North End. The resultant North End Urban Plan (NEUP) builds on the work and vision of the City's Comprehensive Plan to address focus areas of opportunity, equity, resilience, connectivity and quality. The planning effort also featured robust public outreach (even as the Covid-19 pandemic forced remote interactions) to build community support for the plan as an expansion of the 2017 Comprehensive Plan and for the future adoption of a zoning amendment to enable implementation of the plan. The intention is to incorporate the North End Urban Plan by reference in the Comprehensive Plan.*

*To introduce the NEUP's incorporation into the 2017 Comprehensive Plan, the addition of the following page and map of study area is proposed, opening Chapter 3 - Land Use.*

*Add new page-- 3-0 at the beginning of Chapter 3, as follows:*

### **3.0 Incorporation by Reference of the North End Urban Plan, (February 10, 2021)**

The *North End Urban Plan (NEUP)*, attached hereto as Appendix 1, is incorporated in the Comprehensive Plan in its entirety and shall serve to further clarify the vision, goals, policies, and actions for the North End, as delineated on Map 3-0. For this chapter, and all subsequent chapters, the North End Urban Plan shall be the primary guidance document for future development within the outlined area, as it provides greater detail than this base *Comprehensive Plan*. The *North End Urban Plan* seeks to direct redevelopment in Newport's North End in conformance with the vision of the 2017 Comprehensive Plan, and in ways that help address historic inequities and offer more diverse economic opportunities, while creating a safe, comfortable built environment that balances Newport's history with its aspirations for the future.

The *North End Urban Plan* takes the purpose and goals for the North End described in the 2017 *Comprehensive Plan* as its foundation, which includes a description of a portion of the North End Commercial neighborhood as a future jobs hub within the city, referred to in the 2017 Comprehensive Plan as the "Innovation Hub" and in the *NEUP* as the "Innovation District." The outlined North End area also consists of a number of existing residential neighborhood areas, which are expected to experience far less redevelopment than the Innovation District. The *Comprehensive Plan's* corresponding future

land use designation “Mixed Use, Innovation” is intended to support startup/incubator types of businesses focused on the Blue Economy (resiliency-oriented industries and marine-focused technology, R&D, and production), its ancillary uses, and digital technology, as outlined on page 3-17. As an area plan that is incorporated into the *Comprehensive Plan* by reference, the *NEUP* remains consistent with the *Comprehensive Plan* and expands on the themes of opportunity, equity, resilience, connectivity and quality.

Newport’s North End Innovation District is poised for transformation: the reconstruction of the Newport Pell Bridge approaches will remove large amounts of expressway infrastructure, freeing up land for new development; meanwhile, there is increased interest in redevelopment of the 25-acre former jai alai facility. These two major projects alone could create over 50 acres of new development with Blue Economy-focused jobs and new commercial economic activity alongside ancillary uses such as housing, retail and open space. Additionally, more moderately-scaled redevelopment opportunities elsewhere in the Innovation District, such as on smaller parcels along JT Connell Highway, are also likely in the coming years, reflecting the significant changes to infrastructure that are expected. The existing stable residential neighborhoods of the North End could benefit directly and indirectly from the new Blue Economy development, additional retail and services, and workforce housing, if they are consistent with the *Comprehensive Plan* and the community’s goals. The *NEUP* seeks to make that connection to achieve these benefits.

The *NEUP* includes an appendix entitled, Character-Based Code, a form-based code developed for the North End Innovation District. It is a long-term goal to adopt this code for the designated area of the North End, and use this code as a model for future rezoning of other identified and defined character areas of the City. In the short and medium terms, the Character-Based Code will serve as design guidelines through its incorporation into the *Comprehensive Plan*, and along with the Quality Theme of the *NEUP*, will provide clear visual guidance for development within the Innovation District.

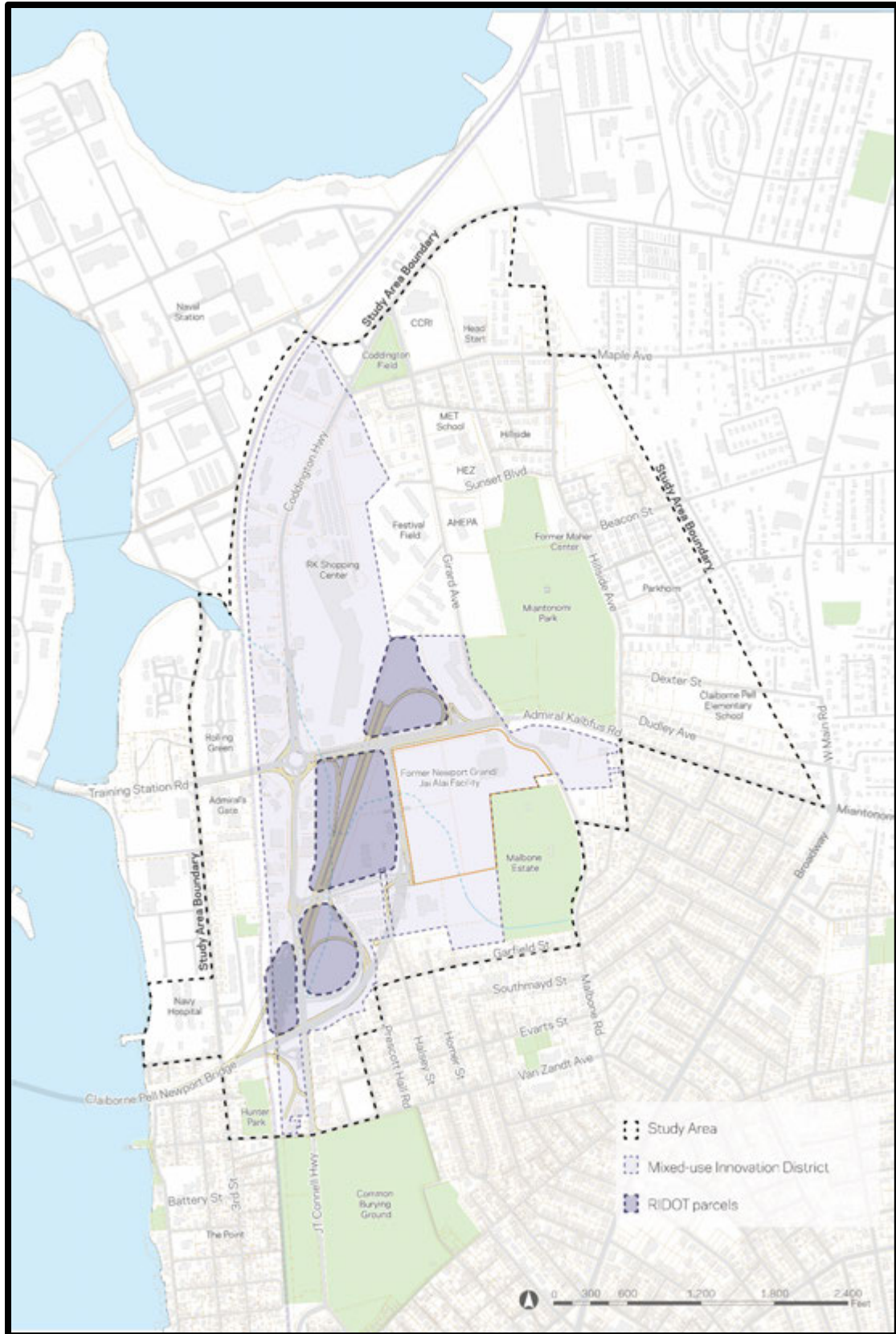

Map 3-0, North End Urban Plan Area.

2. Location:       **Chapter 3 – Land Use**  
                          Future Land Use Map (FLUM), Map 3-6, Page 3-16

*Description of amendment: The FLUM, as included in the 2017 Comprehensive Plan, calls for Mixed Use, Innovation zoning to replace the entirety of the Commercial-Industrial zoning district and a smaller area of the Residential R-10 zoning district. With the understanding that the Future Land Use Map is a general guidance tool, high-density residential use is supported in the future vision for the area, and the existing multifamily housing is compatible with this vision and is supported with the retention of the residential zoning, the intention is to retain the existing residential zoning to support a diversity of housing options within the North End, as well as citywide. The FLUM shall include this detail map section, see attached.*





Legend

Future Land Use

- Estate Residential
- Low Density Residential
- Medium Density Residential
- High Density Residential
- Light Commercial
- General Commercial
- Light Industrial
- Mixed-Use, Waterfront
- Mixed-Use, Innovation
- Traditional Maritime
- Parks and Open Space
- Water

- Institutional Overlay
- Permanently Protected Open Space

City Boundary

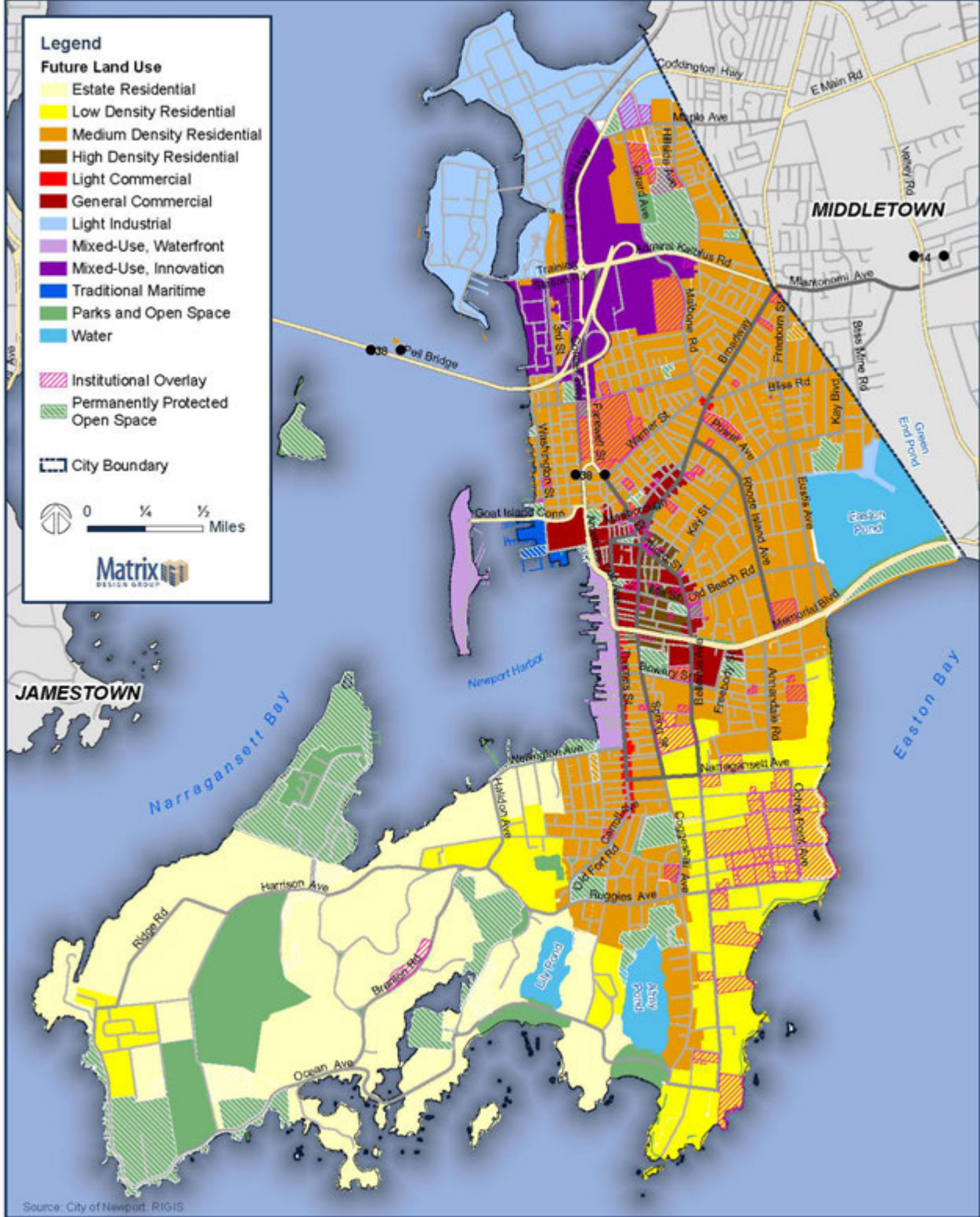

Source: City of Newport, RIGIS

This map reflects Amendment 1, February 10, 2021

3. Location:           **Chapter 3**  
                              3.2 Goals and Policies, Zoning-Future Land Use Map Analysis, Map 3-7,  
                              3.3 Page 3-21  
                              and  
                              **Chapter 14**  
                              14.2 Zoning/FLUM Analysis, Map 14-1, Page 14-5

*Description of amendment: This Map, Zoning – Future Land Use Map Analysis appears in two separate chapters; and both locations are revised to be in accordance with the change in the FLUM.*

*The intention is to retain the existing residential zoning in a limited area of the Innovation District to support a diversity of housing options within the North End, as well as citywide. This Map (in both locations) is updated for consistency.*

Map Title: Zoning – Future Land Use Map Analysis

Eliminate:

6. Existing Zoning: Residential (R-10) FLUM: Mixed Use, Innovation

Replace with:

6. Existing Zoning: Residential (R-10) to remain.

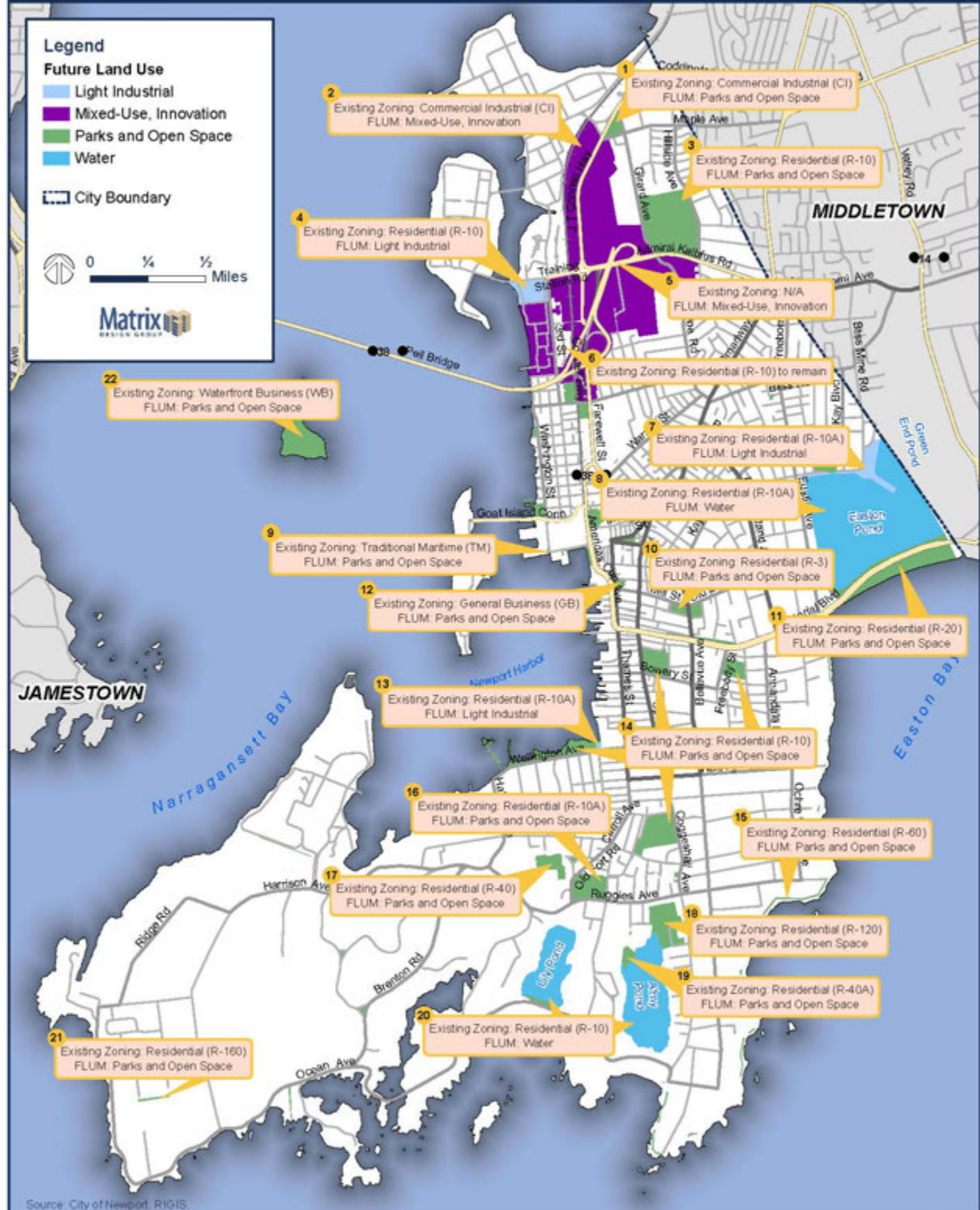

Source: City of Newport, RIGIS



**Legend**

**Future Land Use**

- Light Industrial
- Mixed-Use, Innovation
- Parks and Open Space
- Water

City Boundary

0 1/4 1/2 Miles

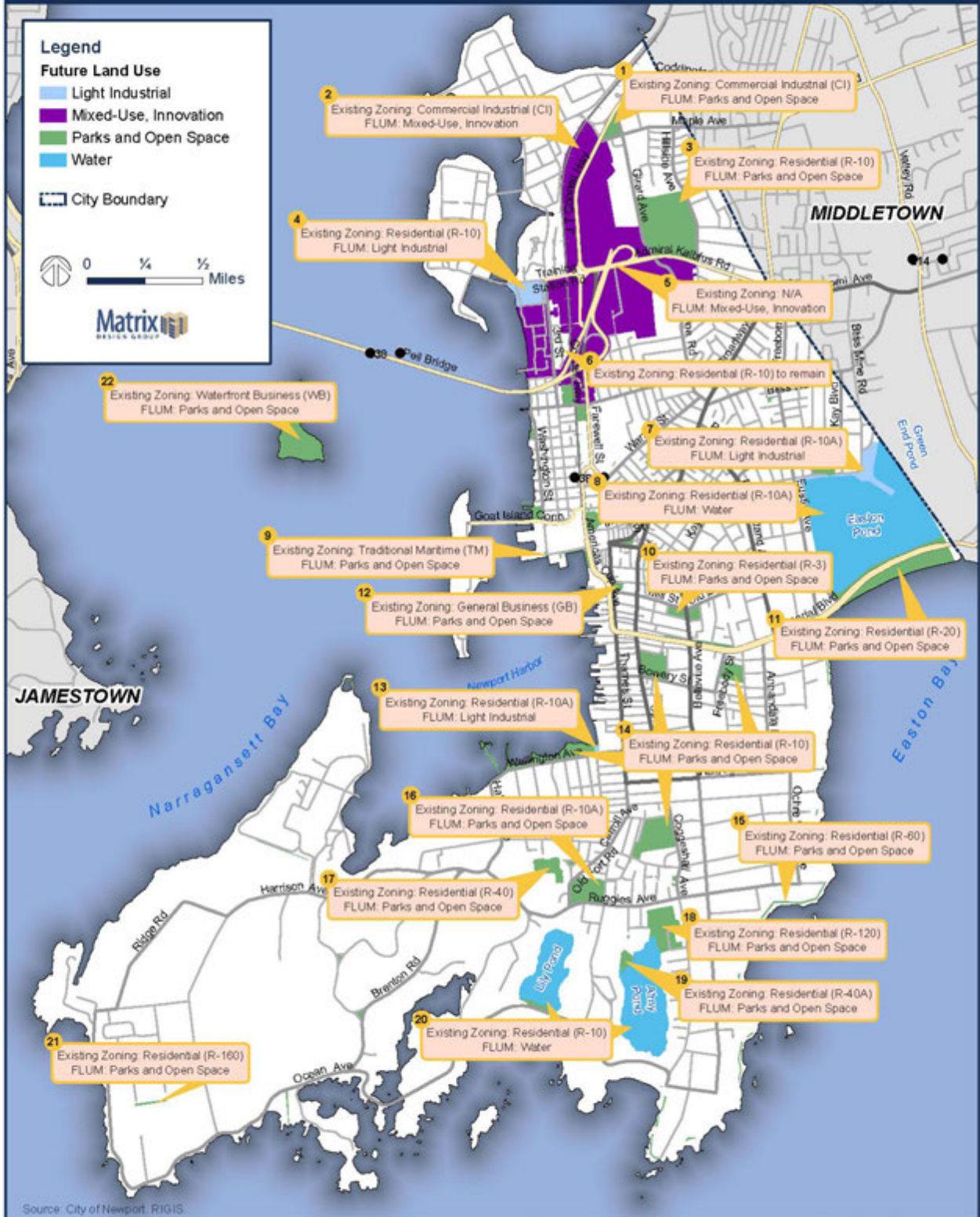

Source: City of Newport, RIGIS.

4. Location: **Chapter 3**  
3.2 Goals and Policies, Page 3-17

*Description of amendment: The Mixed-Use, Innovation future land use designation description is revised to replace Commercial-Industrial and R-3 Residential with Urban Innovation Village District and Urban Innovation, Floating Zone District as permitted zones.*

Existing text:

The Mixed-Use, Innovation land use designation is located in Newport’s North End, surrounding the existing Pell Bridge ramp right-of-way. The intent of this land use category is to support the development of incubator/accelerator type businesses focused on resilience/climate change, ocean, alternative energy systems, defense (underwater, maritime and cyber security) and digital industries, their support sub-sectors, associated training and job creation center, as well as ancillary financial, commercial and retail/hospitality support services. High density residential uses are permitted if supportive of businesses in this designation. The only zoning districts permitted in this land use category are Commercial-Industrial, R-3 Residential, and Open Space and Recreational.

Proposed text:

The Mixed-Use, Innovation land use designation is located in Newport’s North End, surrounding the existing Pell Bridge ramp right-of-way. The intent of this land use category is to support the development of incubator/accelerator type businesses focused on resilience/climate change, ocean, alternative energy systems, defense (underwater, maritime and cyber security) and digital industries, their support sub-sectors, associated training and job creation center, as well as ancillary financial, commercial and retail/hospitality support services. High density residential uses are permitted if supportive of businesses in this designation. The only zoning districts permitted in this land use category are Urban Innovation Village District and Urban Innovation, Floating Zone District, and Open Space and Recreational.

5. Location: **Chapter 3**  
Table 3-4 – Inconsistencies Table, Page 3-20  
and  
Table 14.2 – Inconsistencies Table, Page 14-4

*Description of amendment: The Inconsistencies Table is revised in accordance with the change in the FLUM.*

Table 3-4 – Inconsistencies Table, Page 3-20 and Table 14.2 – Inconsistencies Table, Page 14-4

Map ID	Existing Zoning	Proposed Zoning	FLUM
6.	Residential (R-10)	Innovation Hub Mixed Use	Mixed Use, Innovation
6.	Residential (R-10)	No change	No change

6. Location: **Chapter 3**  
3.3 Goals and Policies, Page 3-25

Description of amendment: Land Use Policy LU-1, supports the city's first Land Use Goal, LU-1 "To provide a balanced City consisting of residential, commercial, and employment uses consistent with the character, environmental resources and vision of the community."

The intention is to include consideration a form base code, along with other alternative development standards, as a tool to support the goal of providing a balanced City that is consistent with the character of the community. The policy should also be corrected to assign the Floating Zone to the future land use designation, not outdated zoning districts.

Existing Text:

LU Policy LU-1.5, page 3-25

The City shall encourage the use of the Floating Zone Overlay, in the waterfront Business, Traditional Maritime, or Commercial/Industrial zoning districts including the Innovation Hub Area. This could include the use of alternative performance-oriented development standards, mixed uses, and other development and planning techniques that will support a vibrant and flexible economic opportunity area.

Proposed text:

The City shall encourage the use of the Floating Zone in the Mixed-Use, Waterfront and Mixed-Use, Innovation future land use designations. This could include the use of *form or character base codes*, alternative performance-oriented development standards, mixed uses, and other development and planning techniques that will support a vibrant and flexible economic opportunity area.

7. Location:           **Chapter 3**  
                                  3.3 Goals and Policies, Page 3-26

Description of amendment: A new Land Use Goal LU-3 with corresponding policies will bring implementation of the North End Urban Plan to the fore. Additional information available regarding implementation is available in the North End Urban Plan itself.

*Insert new goal and policies as follows:*

Goal LU-3: Achieve the vision put forth by the North End Urban Plan.

Policy LU-3.1: The City, in collaboration with the Rhode Island Department of Transportation, shall improve rights-of-way in accordance with the North End Urban Plan.

Policy LU-3.2: The City shall promote outstanding design in the Innovation District that supports current and future issues and needs.

Policy LU-3.3: The City shall prioritize development that creates jobs in accordance with the North End Urban Plan.

Policy LU-3.4: The City shall work to mitigate educational, wealth, opportunity, and geophysical disparities through public process and community benefits.

8. Location:       **Chapter 3**  
                          3.4 Implementation Actions, Page 3-26  
                          And  
                          Chapter 14, 14.3 Land Use, Page 14-6

*Description of Amendment: Add new Goal LU-3 and Implementation Actions letters A through G.*

A) Require high-quality urban design elements for development within the North End, and embrace Newport's existing context – history, geography, climate, economy and architecture – as a source of inspiration for contemporary design within the Innovation Hub. (High, \$-\$\$\$ , On-going, Planning and Economic Development, Planning Board, Design Review)

B) Utilize the North End Urban Plan, Appendix A -Character-based code, as design guidelines to guide appropriate design within the Innovation Hub. (High, \$, On-going, Planning and Economic Development, Planning Board)

C) Seek uses that bring new higher paying jobs to Newport and provide opportunity for growth, and work with residents to secure those jobs. (High, \$, On-going, Planning and Economic Development)

D) Support workforce training, particularly in fields of technology, maritime, and maker sectors. (High, \$, Mid, Short & On-going, Planning and Economic Development, City Council)

E) For Development within the Innovation Hub:

- Determine the impact of development projects on residential areas and identify benefits that may help mitigate any negative impact.
- Provide community benefits that are informed by and improve the quality of life for residents.  
(High, \$, Mid, short & On-going, Community Benefits Committee, City Council, Planning and Economic Development)

F) Encourage a mix of supportive uses in the North End reflective of the community's wants and needs. (High, \$, On-going, Community Benefits Committee, Planning and Economic Development, Planning Board)

G) Develop an understanding of factors that contribute to displacement and implement solutions such as taxation measures, community benefits or other development incentives to support neighborhood stability and mitigate displacement. (High, \$, On-going, City Council)

9. Location:       **Chapter 3**  
                          3.4 Implementation Actions, Page 3-26  
                          and  
                          **Chapter 14**, 14.3 Land Use, Page 14-6

*Description of amendment: The Implementation Program is changed to reflect the City's long-term goal of adopting the Character code in the North End and potentially adopting a version of a character code in other areas of the City. This change is accomplished by the addition of text as follows.*

Existing Text:

GOAL LU-1 To provide a balanced city consisting of residential, commercial, and employment uses consistent with the character, environmental resources and vision of the community.

C) Update City's Zoning Map to reflect the changes noted on Map 14-1 and Table 14-2.

Add text below to section C. above:

C.1) Adopt the Character Based Code included in the North End Urban Plan in the designated area of the North End; identify additional character areas throughout the city that would benefit from the adoption of a form based-code and update the City's Zoning Map accordingly.

Add the following to the chart

C.1 meets the following city objectives:

Prosperous, Beautiful, Happy, Destination, Collaborative, Smart, Healthy, Resilient

Priority: Mid

Time: Long

Cost: \$

Responsibility/CIP

- City Council
- Planning and Zoning Board
- Planning

10. Location: **Chapter 4**  
Economic Development, Page 4-9

*Description of amendment: The 2017 Comprehensive Plan references the City's Economic Development Plans, Programs, and Incentives, with a special section on the North End on page 4-9. This section outlines the City's economic development focus on the North End. The second bullet references the Innovation Hub.*

*A new sentence should be appended to the second bullet, as follows:*

The North End Urban Plan details the land use and development requirements for the North End and identifies utilities, transportation, and other investments to facilitate economic development.

11. Location: **Chapter 4**  
4.3 Implementation Actions, Page 4-13  
And  
**Chapter 14**  
14.4 Economic Development, Page 14-9



Description of Amendment: Add Implementation action under GOAL ED-1

M) Ensure new development in the North End is consistent with city goals regarding climate change and environmental stewardship and includes support and job-training programs for residents. (High, \$-\$\$, On-going, Public Utilities, Planning and Economic Development, educational institutions, Planning Board, City Council, Resiliency)

12. Location: **Chapter 5**  
Housing Page 5-35

Description of amendment: The 2017 Comprehensive Plan lists two North End neighborhoods: North End Commercial and North End Residential. The second paragraph of the North End Commercial section mentions the Innovation Hub. With the adoption of the North End Urban Plan, the last sentence is outdated. A reference to the North End Urban Plan in the description of the North End Residential neighborhood area will provide opportunity for additional information regarding this neighborhood.

Strike the last sentence from the description of the North End Commercial neighborhood area and insert the following sentence:

Existing text:

The North End Commercial neighborhood is also home to the plan for the Newport Innovation Hub. The goal of this plan is to redesign the Claiborne Pell Bridge and develop the newly available land into a hub of businesses with a focus on innovation, sustainability, and civic economic development. ~~The Innovation Hub is still in the planning stages.~~

Proposed text:

The North End Commercial neighborhood is also home to the plan for the Newport Innovation Hub. The goal of this plan is to redesign the Claiborne Pell Bridge and develop the newly available land into a hub of businesses with a focus on innovation, sustainability, and civic economic development. **The North End Urban Plan outlines the vision for the Innovation Hub, as well as abutting areas.**

Append the following sentence to the end of the North End Residential section:

**The North End Urban Plan provides additional detail regarding the North End Residential neighborhood area.**

13. Location: **Chapter 5**  
5.3 Implementation Actions, Page 5-28  
And  
**Chapter 14**  
14.5 Housing Element, Pages 14-13

Description of Amendment: Add Implementation Action under GOAL H-2, A

A.1) Monitor and respond to displacement in neighborhoods within the North End. (Mid, \$, On-going, Community Development Division)

14. Location: **Chapter 7**  
7.2 Goals and Policies, Page 7-16, 17

Description of Amendment: Add **Policy T-1.7, Page 7-16**

Policy T-1.7: The City shall seek improved pedestrian and bicycle accommodations in the North End.

Description of Amendment: Add **Policy T-2.7, Page 7-16**

Policy T-2.7: The City shall create more transportation options for visitors and residents.

Description of Amendment: Add **Policy T-4.5, Page 7-17**

Policy T-4.5: The City shall protect North End neighborhoods from large vehicle traffic.

15. Location: **Chapter 7**  
7.3 Implementation Actions, Page 7-18,19,20  
And  
**Chapter 14**  
14.7 Transportation & Circulation Element, Page 14-18

Description of Amendment: Add *Implementation Actions under Goal T-1*

D.) Coordinate with RIDOT to improve regional connections and optimize multimodal transportation development opportunities within the North End. (High, \$-\$\$\$ , On-going, Planning and Economic Development, Public Services)

E) Coordinate with RIDOT to include a welcoming gateway to the City in the Pell Bridge realignment project for those arriving via the Newport Pell Bridge. (High, \$-\$\$, Short, Planning and Economic Development, Design Review)

Description of Amendment: Add *Implementation Action under Goal T-4*

G.) Consider the traffic demands of vehicular traffic through the North End and apply traffic calming strategies. (Mid, \$\$, On-going, Public Services).

16. Location: **Chapter 9**  
9-3 Implementation Actions, Page 9-19  
And  
**Chapter 14**  
14.9, Natural Resources Element, Page 14-23

Description of Amendment: Add *Implementation actions under GOAL NR-1*

D) Continue to expand Newport's urban forest in the North End. (Mid, \$\$, On-going, Division of Parks, Resiliency)

E) Promote tree canopy in North End urban communities to help combat climate change. (Mid, \$, On-going, Division of Parks, Resiliency)

17. Location: **Chapter 13**  
13.3 Implementation Actions, Page 13-17

And

**Chapter 14**

14.13 Natural Hazards and Climate Change Element, Page 14-34

*Description of Amendment: Add Implementation Actions under GOAL NHCC-1*

C) Utilize opportunities associated with the Pell Bridge ramp realignment project and new development to manage/mitigate stormwater and sea level rise. (High, \$\$\$-\$\$\$\$, On-going, Public Utilities, Resiliency)

D) Coordinate with governmental agencies and regional and local academic institutions to better prepare for climate change. (Mid, \$, On-going, Resiliency)





---

# NEWPORT NORTH END URBAN PLAN

---



City of Newport

February 10, 2021

This document represents 6+ months of hard work by the the City of Newport's Department of Planning and Economic Development and their consultant team, led by the firm NBBJ. Numerous hours were contributed by countless volunteers, most notably Planning Board Chair Kim Salerno, who shepherded the project. The project team wishes to recognize her leadership, as well as that of other major project participants:

**City Council**

- Jeanne Marie Napolitano, Mayor, Council Chair
- Lynne Underwood Ceglie, Vice-Chair
- Jamie Bova, At-Large Councilor
- Elizabeth Fuerte, At-Large Councilor
- Angela McCalla, First Ward
- Charles M. Holder, Second Ward
- Kathryn E. Leonard, Third Ward
- Justin McLaughlin\*
- Susan D. Taylor\*

**Planning Board**

- Kim Salerno, Chair
- Jeff Brooks, Vice Chair
- Liam Barry, Secretary
- Steven Berlucchi
- Elizabeth Fuerte
- Richard Haggis
- Paul Marshall
- John Oliveira
- Melissa Pattavina

\*term concluded 11/30/2020

**Planning & Economic Development Department**

- Joseph Nicholson, City Manager
- Christopher Behan, City Solicitor
- Thomas Shevlin, Communications Officer

- Trish Reynolds, Director
- Peter Friedrichs, City Planner
- Helen Johnson, Preservation Planner
- Sarah Atkins, Community Resilience Specialist

**Steering Committee**

Chuck Allott  
Jeff Brooks  
Drew Carey  
Bill Corcoran  
Lilly Dick  
Jim Dring  
Mohamad Farzan  
Elizabeth Fuente  
David Galvin  
Isabel Griffith  
Dan Herchenrether  
Lola Herrera Ximenez  
Peter Janaros  
Tanya Kelley  
Nycole Matthews  
Rick O'Neill  
David Pedrick  
Kim Salerno  
Anand Toprani  
Alyce Wright

**Consultant Team**

**NBBJ**

Alan Mountjoy, AIA  
Chris Herlich, AICP  
Rodrigo Guerra Delgado

**Engagement Lab**

Halvorson Design/Tighe&Bond

McMahon

Code Studio







# CONTENTS

## Executive Summary

p.06

## 1 Introduction & Planning Context

p.17

Goals of the Plan

Purpose & Use of the Plan

Select Prior & Concurrent Planning Efforts

Existing Conditions Analysis

Public Engagement Process

## 2 Plan Framework

p.45

A Vision for 21<sup>st</sup> Century Living & Working

Planning Themes & Principles:

Opportunity

Connectivity

Resiliency

Equity

Quality

## 3 Innovation Character Subdistricts & Design Guidelines

p.85

Urban Village Mixed Use with 5 Stories

Urban Village Mixed Use with 3 Stories

Business Corridor

Maker

Maker Tech

Waterfront Campus

## 4 Implementation

p.101

Development Actions

Infrastructure Actions

# EXECUTIVE SUMMARY

**The North End Urban Plan (NEUP) seeks to direct redevelopment in Newport's North End in ways that help address historic inequities and offer more diverse economic opportunities, while creating a safe, comfortable built environment that balances Newport's history with its aspirations for the future.**

The North End was one of the last places in the city of Newport to develop; while much of the city was originally constructed during the 18<sup>th</sup> and 19<sup>th</sup> centuries, the North End did not experience significant development until the 20<sup>th</sup> century. As a result, it faces many of the same challenges as other districts with 20<sup>th</sup> century development patterns, including automobile-dominated infrastructure, large single-use subareas, and comparatively low-quality public realm. The North End is physically and economically disconnected from the rest of the city, separated by infrastructure and thus lacking access.

The North End Urban Plan (NEUP) takes the purpose and goals for the North End described in the 2017 *Comprehensive Plan Update* (*Comprehensive Plan*) as its foundation, which includes a description of the North End commercial neighborhood as a future jobs hub within the city, the "Innovation Hub." The North End also consists of a number of existing residential neighborhood areas, which are expected to experience far less redevelopment than this Innovation District. The *Comprehensive Plan's* corresponding future land use designation "Mixed Use, Innovation" is intended to support startup/incubator types of businesses focused on the Blue Economy (resiliency-oriented industries and marine-focused technology, R&D, and production), its ancillary uses, and digital technology. As an area plan that will be incorporated into the *Comprehensive Plan* by reference, the NEUP must remain consistent with the *Comprehensive Plan*.

Newport's North End Innovation District is poised for transformation: the reconstruction of

Opposite: The study area comprises a large portion of the northern section of the city of Newport. It is effectively bounded by the city line with Middletown, Naval Station Newport, and the former Elizabeth Marsh.

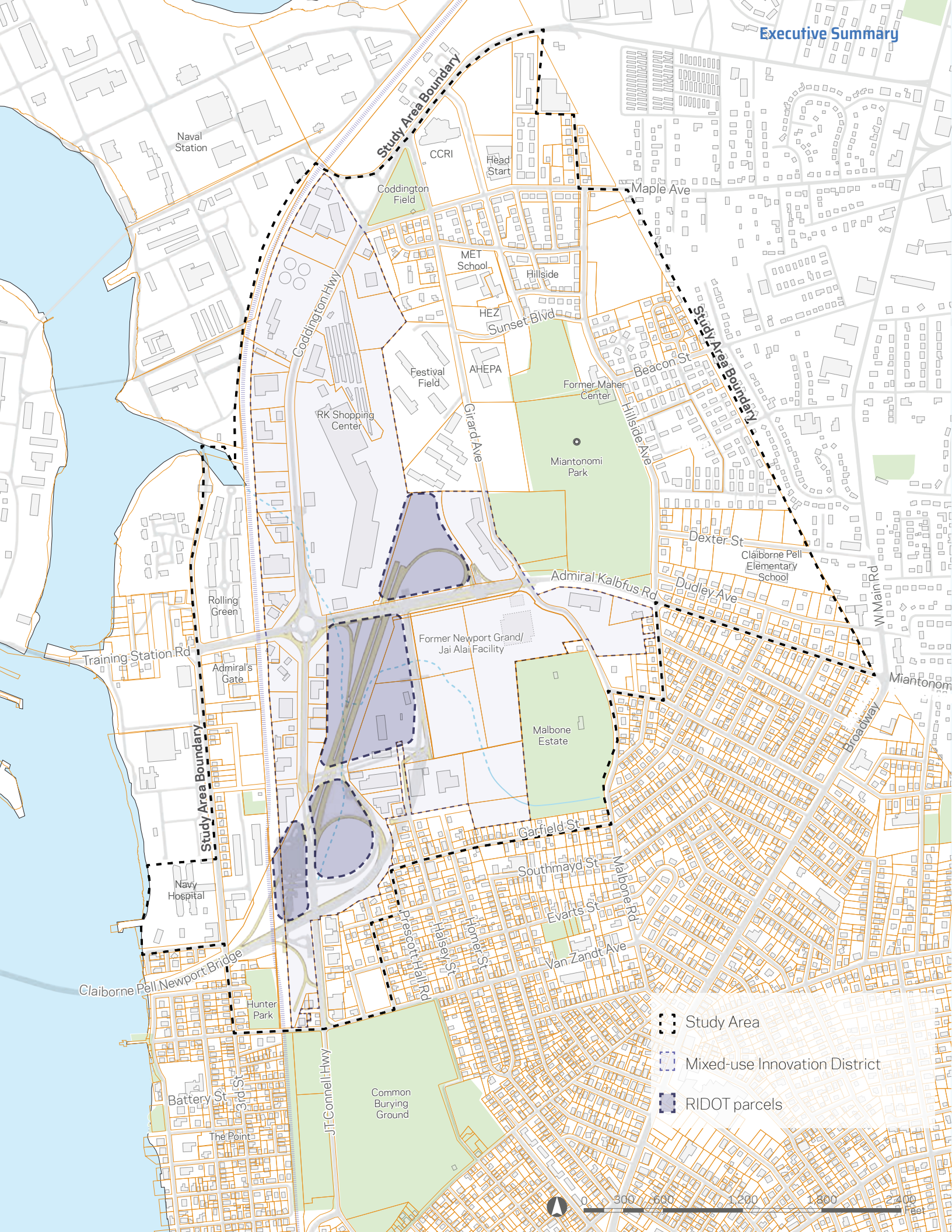



the Newport Pell Bridge approaches will remove large amounts of expressway infrastructure, freeing up land for new development; meanwhile, among other potential changes in use, there is increased interest in redevelopment of the 25-acre former jai alai facility. These two major projects alone could create over 50 acres of new development with Blue Economy-focused jobs and new commercial economic activity alongside ancillary uses such as housing, retail and open space. Additionally, more moderately scaled redevelopment opportunities in the Innovation District, such as on smaller parcels along JT Connell Highway, are also likely in the coming years, reflecting the significant changes to infrastructure that are expected. The existing stable residential neighborhoods of the North End could benefit directly and indirectly from the new Blue Economy development, additional retail and services, and workforce housing if they are consistent with the *Comprehensive Plan* and the community's goals. The *NEUP* seeks to make that connection to achieve these benefits.

To better define the community's goals, a robust public engagement effort for the *NEUP* extended from January to June of 2020 and included an in-person public forum, neighborhood group meetings, drop-in hours, stakeholder calls, and an online survey. Approximately 150 participants attended the Public Forum in February and 148 responded to 46 specific questions in the online survey during the COVID-19 quarantine months of April through June. The project team conducted many other personal outreach activities to develop a plan they believe substantially incorporates the community's goals. The project team presented draft recommendations at a public meeting held via Zoom on July 30th, where 75 attendees reviewed the final recommendations and participated in a town-hall-style question and answer session.

The *NEUP* outlines five Themes to guide redevelopment in the North End that are based on input from the general public, City leaders, and professional expertise:

# Opportunity

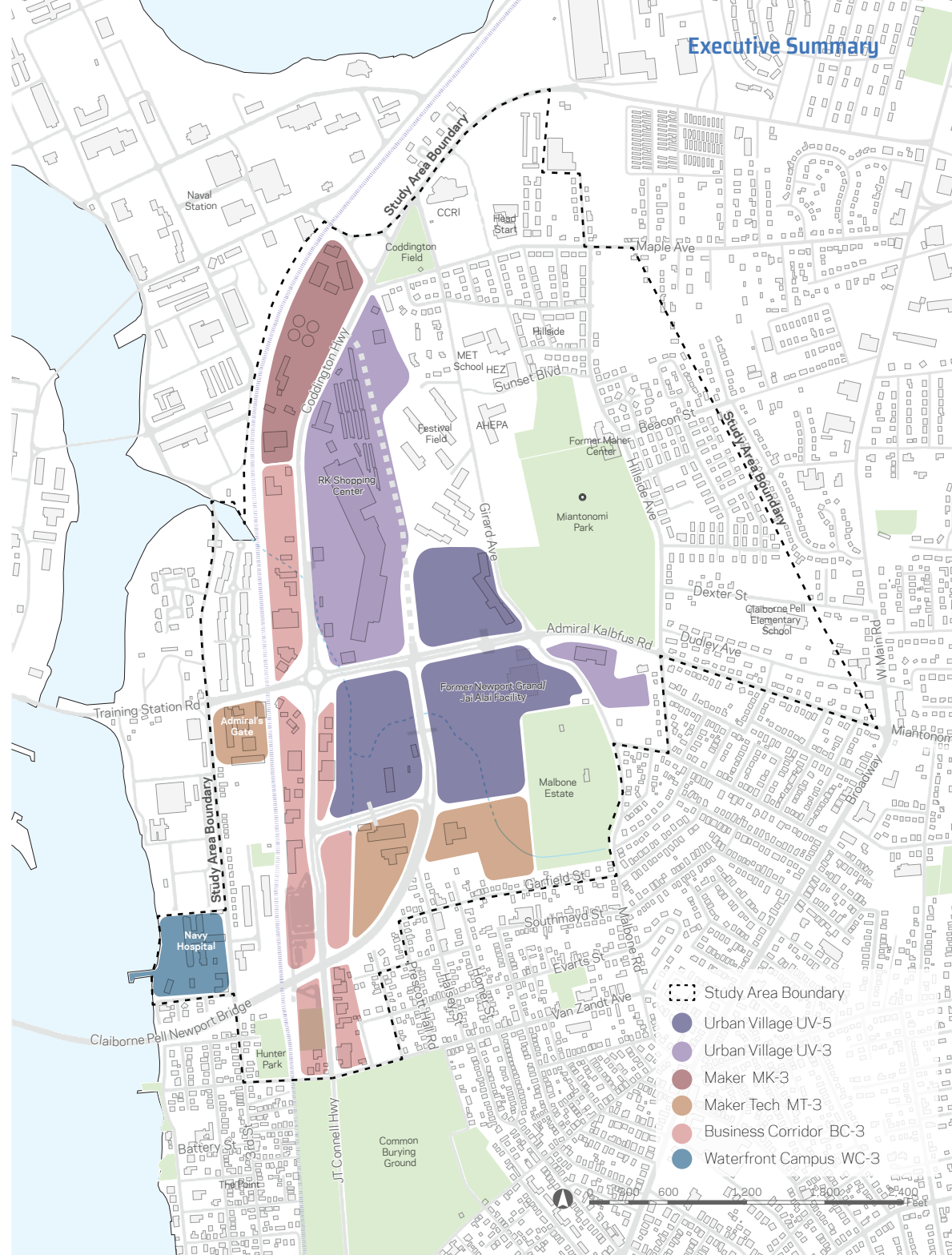

*Opportunity* is focused on supporting a range of jobs that will diversify Newport's economy and improve year-round employment, while protecting the residential areas outside the Innovation District from substantial change and supporting the institutions active in the neighborhood. The priority for the Innovation District will be the attraction and retention of innovative and entrepreneurial activities within the Blue Economy, Green Economy, and

technology sectors, advanced research and production, and businesses such as those in the Tradesmen's Center. Though the Innovation District is proposed to expand as a jobs center, it must also make designated space available for ancillary and supportive uses, such as housing, retail, hospitality, and community amenities. Furthermore, future uses must be compatible with adjacent existing uses to maintain the continuity of neighborhood character.



# Connectivity

Connectivity is needed in the North End, where a history of industrial uses and large-scale car infrastructure has dominated the landscape, creating challenges for cyclists and pedestrians, and an incomplete transportation network. The Rhode Island Department of Transportation (RIDOT)-led Pell Bridge Approaches Project currently underway will transform the North End in a positive way by removing large areas

of expressway infrastructure and simplifying movement through the area. The proposed rail-with-trail will also dramatically improve connectivity between the North End and Newport's downtown and waterfront. Private development and public investment should extend pedestrian networks to connect neighborhoods to open spaces, retail services, and the waterfront.

# Resiliency

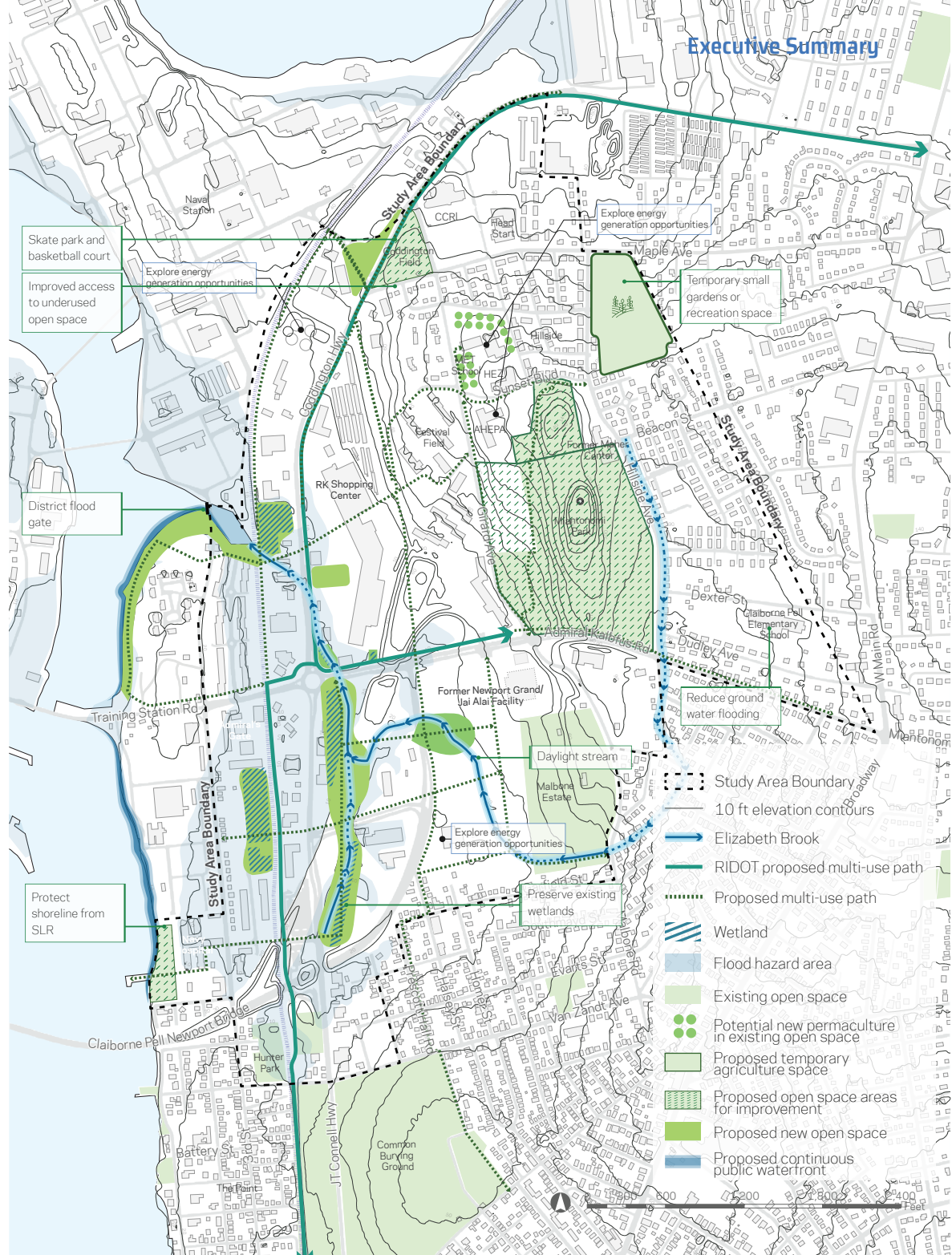

Resiliency is a strategic economic development requirement for Newport and the City has established itself as a national leader in resilient planning and growth in recent years. It is an important consideration for the North End, as a large portion of the areas along JT Connell Highway and even further inland lie on former marshlands at low elevation with significant risk of flooding. RIDOT's realignment of the Newport Pell Bridge approaches will begin addressing

some of the local physical resiliency constraints, but sea-level rise will further threaten the area in the coming decades unless investment is made where Elizabeth Brook joins Narragansett Bay to limit seasonal or episodic storm surges into the North End. Sustainable design, development, and construction practices must include permitting authority review of greenhouse gas emissions, stormwater treatment, and shared parking and trip reduction strategies.

# Equity

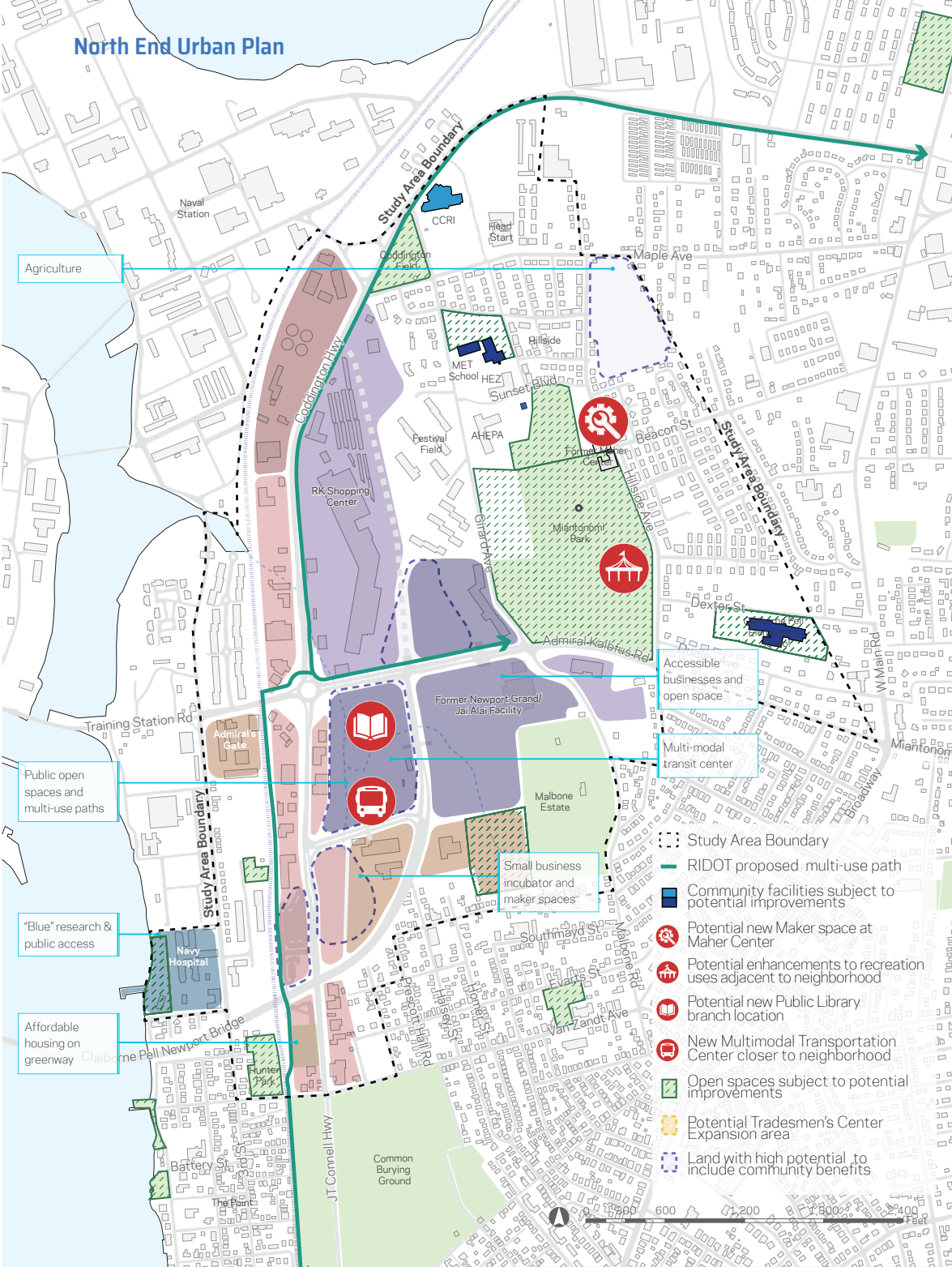

Equity is a significant concern of residents of the North End, who have long formed the backbone of Newport’s tourism, service, and industrial workforces. Despite their importance to the local economy, a range of services and amenities are underprovided in the North End, such as outdoor recreational facilities, economic opportunity assistance, and access to educational

resources. Local residents expressed a range of aspirations for community benefits that should be included in future redevelopment of the area. These community benefits can be built on publicly-owned parcels, required by zoning, incentivized during site plan review, or negotiated in development agreements, among other mechanisms.



# Quality



Quality is a critical issue, as the North End is the “gateway” to Newport from the Newport Pell Bridge as well as from areas to the north, and the existing physical conditions in the area generally do not reflect the character that defines Newport. The redevelopment of the former jai alai facility will figure prominently in the transformation of this gateway, as will parcels made available once the Newport Pell Bridge approaches have been rebuilt. Both the pattern of new development and the

architectural quality is of great interest to Newport residents, businesses, and visitors alike. Development regulations and guidance must together ensure that all new development is respectful of Newport’s rich architectural heritage and its scale, while accommodating new uses and building types and creating an excellent public realm. The design guidance in of this Plan and the proposed form-based code in *Appendix A* are robust tools for achieving the goals of the *NEUP*.



Implementation of the *NEUP* will depend upon a range of public and private actions. Primarily, RIDOT must complete its reconstruction of the Newport Pell Bridge approaches in general accordance with the *NEUP* in order to realize any of the large redevelopment plans envisioned. Assuming that the City is the receiving entity for excess land disposition, the City can build needed facilities and sell or lease additional land for private redevelopment. Other potential sites for redevelopment include the former incinerator site and the City Yard, the relocation of which will facilitate even more expansive and effective redevelopment of the area.

The City will also establish appropriate rezoning of the current Commercial Industrial zoning district in the North End to better address the goals for the Innovation District, ensuring the goals of the *NEUP* can be realized. Like the character of the existing conditions in the District, the Innovation District zoning should be nuanced in its regulation of development to account for the variety of conditions within the area. Site plan review will also be a critical tool to ensure that future private development is planned, designed, and constructed in conformance to the recommendations of the *NEUP*. The *NEUP* calls for minimum public open space requirements for large projects to meet the goals of the *Tree, Parks, & Open Space Master Plan*.

Investments in transportation links such as future roadways including a Halsey Street extension, improved bicycle infrastructure, and pedestrian crossing facilities will need to be incorporated into future capital planning budgets. Municipal capital investments will need to be balanced with potential funding from private, state, and federal sources, including funds for protection from climate change and sea-level rise, as well as community benefits derived via development.

Ultimately, the North End Urban Plan creates a context for promoting a diversified economy where it is needed most. National trends in economic development have brought a renewed focus to urban areas as the innovation economy has realized the benefits of locating in an urban setting. By converting the automobile-oriented sprawl of the North End to a dense, walkable, urban environment, Newport can capitalize on this national trend, while creating significant quality-of-life improvements for Newporters. This new development typology is reflective of Newport's historic patterning, creating new opportunities for charming environments. The Plan builds on Newport's small-city feel and creates a framework for the regulatory amendments that will provide both the public and private sector with the tools to achieve desired growth.





# 1

# INTRODUCTION & PLANNING CONTEXT



# Goals & Purpose of the Plan

Newport's 2017 *Comprehensive Plan Update (Comprehensive Plan)* identifies three primary areas of Newport: the North End, the Central Corridor, and Newport Neck. The North End is "broadly defined as the area north of Route 138/238, Admiral Kalbfus Road and Miantonomi Avenue, but includes the Newport Grand Casino [former jai alai facility] and adjacent development along Halsey Street. Although easterly portions of this area are predominantly residential, the remaining portions of the north end are a mix of industrial, service, residential, institutional, commercial, and other uses. This area is and will continue to be, the focus of public investment and economic diversification efforts." (Page 3-2). This description corresponds with the study area for the North End Urban Plan (*NEUP*, the *Plan*) identified in the solicitation to develop the project team.

The North End has faced a series of challenges – both physical and economic – throughout the 20<sup>th</sup> and early 21<sup>st</sup> centuries, despite a passionate set of residents, community leaders, and business owners and an array of assets distinct within Newport. With the *Comprehensive Plan's* call for an "Innovation Hub" mixed-use district (translated into this document as the "Innovation District"), the Rhode Island Department of Transportation (RIDOT)'s reconstruction of the Newport Pell Bridge approaches and interest in real estate development from the private sector, now is an ideal time to articulate a thorough vision for the North End.

Ultimately, the *NEUP* seeks to direct near- and long-term real estate development in the study area in ways that help address historic inequities and current disadvantages, while creating a built environment that balances Newport's history with its aspirations for the future. That spirit is embodied by Newport's neighborhoods, by its waterfront and connection to the ocean, its unique role in the Blue Economy (resiliency-oriented industries and marine-focused technology, R&D, and production) and associated industries, by its long and proud maritime and architectural history, and by its ambitions for the future.

At the beginning of the planning process, six goals were established for the *NEUP* in an effort to join the goals of the *Comprehensive Plan* with the current desires of the community:

- Build community understanding of key issues
- Create a bold statement for 21<sup>st</sup> century living
- Support sustainable development practices
- Provide visual guidance for developers, decision makers, and the public
- Reconnect the North End to the rest of Newport
- Support diverse development, amenities, and street life welcoming to all Newporters

# Use of the Plan

As an area plan building on previous planning work for the North End, the *NEUP* provides context, community input, and clear delineation of the expectations and aspirations for the North End, with a focus on the built environment. The Plan:

- Serves as a framework for future investment in the North End, describing key physical connections, public realm enhancements, and infrastructure improvements;
- Informs ongoing discussions with RIDOT on the reconstruction of the Newport Pell Bridge approaches and associated potential redevelopment of newly available land;
- Acts as a guidance document for future development, focused on the Innovation District;
- Guides real estate development on land within the study area by providing clarity on community priorities, intended public actions, and desired character; and
- Guides private development on public parcels that may become privately owned through development agreements with public entities.

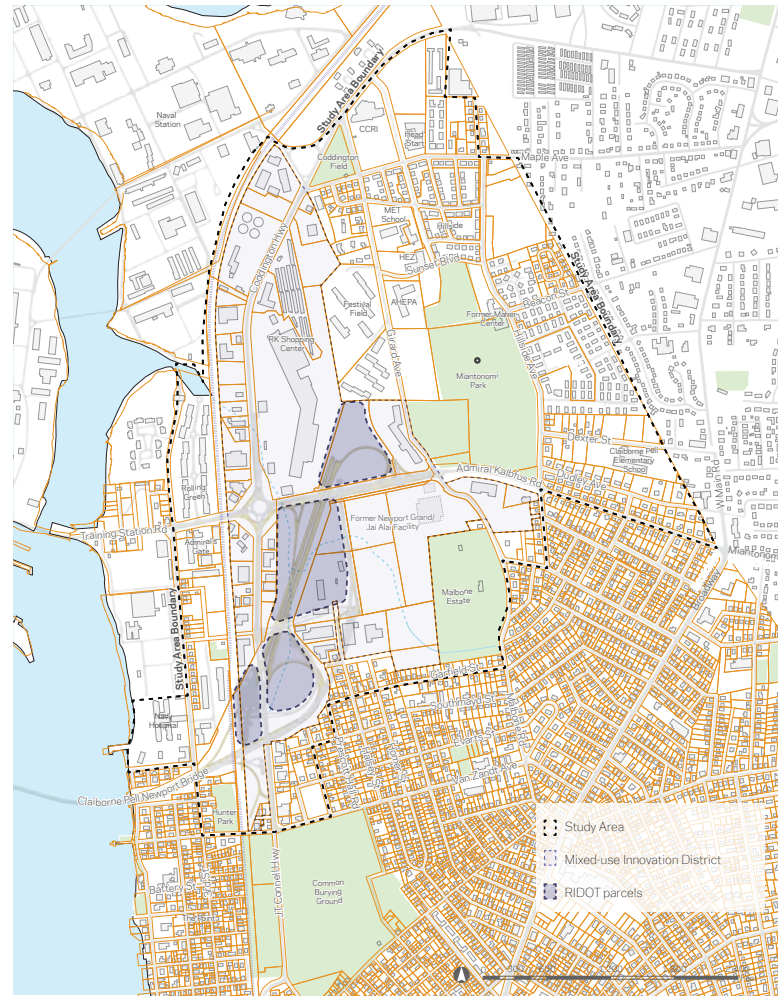

The study area, delineated by the dashed black line, is separate from the proposed rezoning area, in light purple. The *Comprehensive Plan* describes the rezoning area, while this plan establishes a vision for the wider North End as well.

# Select Prior & Concurrent Planning Efforts



## AIPC Aquidneck Island West Side Master Plan

2005

While only directly involving a comparatively small portion of the *NEUP* study area, the AIPC 2005 West Side Master Plan places the North End in the broader setting of regional planning on Aquidneck Island. This master plan envisions the North End, particularly along its western areas, as a corridor, both economically and environmentally. The plan stresses the importance of natural systems and balancing development with long-term sustainability. This plan has recently been reactivated by the AIPC.



## Newport North End Master Plan

2006

The North End Master Plan was completed as part of the Newport Housing Authority's HOPE VI project. The plan identified redevelopment areas included in the *NEUP* and proposed to leverage them as economic development opportunities, which has remained the goal since. Additional topics of concern were circulation, recreation, and housing. The area of study for the North End Master Plan was slightly larger than the

context-based study area of the *NEUP*. The *NEUP* takes a more in-depth analysis of real estate than the North End Master Plan and is a regulatory document, as it is incorporated into the *Comprehensive Plan*. The 2006 master plan was developed prior to RIDOT's current bridge approach planning, though the major themes of mixed uses, additional physical connections, and improved waterfront access still resonate.



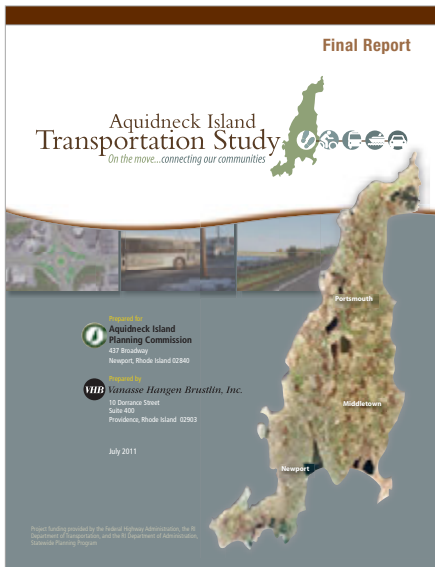

## Aquidneck Island Transportation Study

2011

The Aquidneck Island Planning Commission's Aquidneck Island Transportation Study established policy recommendations for the Island's transportation system. It prioritized safety and the incorporation of land use planning into transportation decisions, while seeking to minimize single-occupant vehicle trips and enhance non-motorized transportation options. Complete streets approaches and strengthened bike and pedestrian networks were noted as critical for the Island, and transit improvements such as bus rapid transit and mobility hubs were also highlighted.

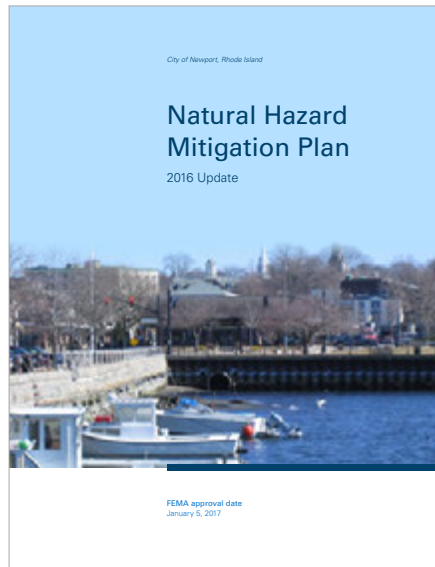

## Newport Hazard Mitigation Plan Update

2016

Newport faces many of the same hazards as other Rhode Island cities, such as storm events and temperature extremes. The plan takes a relatively standard approach to natural hazard mitigation and fails to address critical infrastructure failures and pandemics, which roiled the City in 2019 and 2020, respectively. The City plans to include these elements, along with chemical spills and terrorism incidents, in its mandated 2022 update. The North End is home to several

pieces of critical infrastructure for the city, including schools, stormwater management infrastructure, regional transportation connections, and the wastewater treatment plant.

# Select Prior & Concurrent Planning Efforts

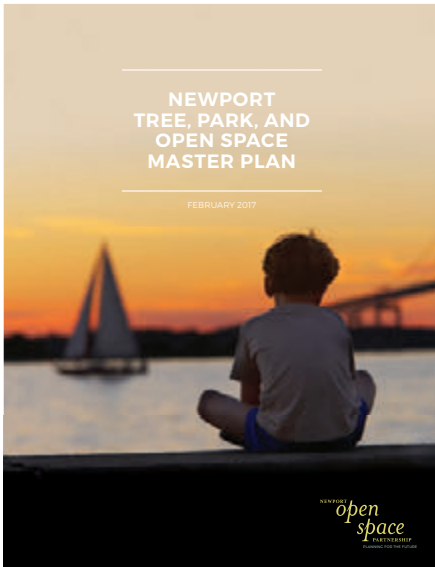

## Newport Tree, Park & Open Space Master Plan 2017

Newport’s natural resources are some of the city’s most treasured assets, and the Tree, Park, and Open Space Master Plan describes the community’s priorities for those resources across many contexts, with an emphasis on creating a complete system that is connected, resilient, equitable, enduring, and active. The plan proposes enhancements to waterfront access, including a park at the former Navy hospital site, and to bicycle routes across the city, including Admiral Kalbfus

Road, Hillside Avenue, and Maple Avenue. The document also identifies the North End as an area underserved by parks and tree canopy, recreational opportunities, and trees. Developed in partnership with nonprofit advocacy groups, the plan was endorsed by the City Council through resolution and “serves as a guide for the City of Newport and its partners to manage, plan, preserve, and protect Newport’s open space assets.”



## Comprehensive Plan Update 2017

The *Comprehensive Plan* is the guiding policy document for the City of Newport and State operations within its bounds, as well as a regulatory tool for zoning and real estate development. The vision section of the document lays out a broad vision for the city, focused on creating a community that is prosperous, vibrant, diverse, resilient, and innovative. It elaborates specific ideals and objectives for the North End, including the creation of an “Innovation Hub.” The *Comprehensive Plan’s*

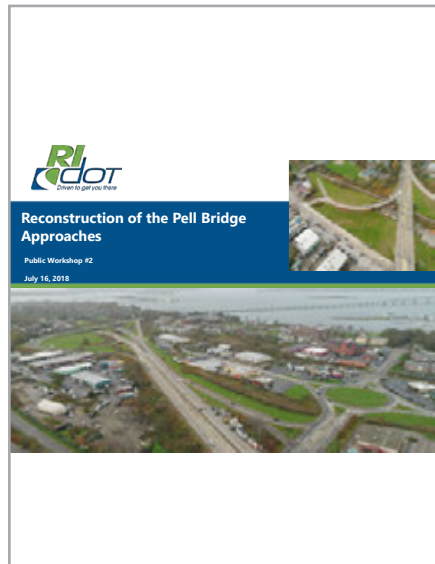

## RIDOT Reconstruction of the Pell Bridge Approaches

Ongoing

Future Land Use Map supports the creation of such a hub through a land use designation called “Mixed Use, Innovation” and proposed “Innovation Hub Mixed Use Zoning”, “which is intended to support startup/incubator types of businesses focused on the [Blue Economy] and digital economy and their ancillary uses.” The *NEUP* has been prepared in line with the spirit of the *Comprehensive Plan*, providing significantly more detail regarding land use.

In response to a vision set forth by the City and further refined by the Rhode Island Turnpike and Bridge Authority (RITBA), RIDOT has been planning to reconstruct pieces of the Newport Pell Bridge approaches in Newport for the last two decades. A federal transportation grant has enabled the project, which completed its Environmental Assessment (EA) in early 2020. The first phase of planning and construction will focus on changes to JT Connell Highway and Coddington Highway north of Admiral Kalbfus Road,

while the second phase will focus on Admiral Kalbfus Road and points south. The design process is still ongoing, but the approved EA provides some indication of likely roadway alignments for the approaches, informing a number of land use and transportation decisions relative to the *NEUP*. RIDOT’s plan calls for separated multi-use paths along Admiral Kalbfus Road and Coddington Highway, a reconfigured rotary with a modern roundabout design, and construction of the rail-and-trail from Admiral Kalbfus Road to the Gateway Center Intermodal Center.

# Existing Conditions Analysis

## Economic Background & Market Opportunities

In accordance with the *Comprehensive Plan*, mixed-use with innovation is the desired land use combination for the areas surrounding the existing Newport Pell Bridge approaches and right-of-way. The intent of the Mixed-Use, Innovation land use category is to “support the development of incubator/accelerator type businesses focused on resilience/climate change, ocean, alternative energy systems, defense (underwater, maritime and cyber security) and digital industries, their support sub-sectors, associated training and job creation center, as well as ancillary financial, commercial and retail/hospitality support services.” (*Comprehensive Plan*, 3-17)

The Newport economy is dominated by the tourism sector, as evident from American Community Survey data published in the Economic Development Chapter of the *Comprehensive Plan*. Unfortunately, the tourism sector is well-known for its low, seasonal wages. By contrast, that same document states that Newport has a higher percentage of jobs than the state as a whole in the scientific, technology, and management sector owing to the presence of the Naval Station Newport and other marine and military research facilities on the Island. This sector has wages much higher than average, therefore one of the stated goals of the *Comprehensive Plan* is to advance various Blue Economy opportunities in the North End. The

Blue Economy is broadly defined as any industry, science or research associated with maritime uses whether civilian or military. Any sites with waterfront access, such as the former Navy hospital, should be prioritized for potential Blue Economy uses in order to maximize Newport’s advantages in this sector. Likewise, existing uses that support the Blue Economy should be preserved and supported with appropriate zoning protection.

The industrial parcels along JT Connell Highway pose challenges for achieving the land use goals outlined in the *Comprehensive Plan*. Large areas along JT Connell Highway and nearby residential neighborhoods including Van Zandt Avenue are prone to episodic and seasonal flooding. The area designated as the Innovation District also has numerous maritime and vehicular repair businesses, the existing waste transfer facility, City Yard, sewage treatment plant and heavily trafficked arterials that create a deteriorated physical environment and potential air quality concerns. The *NEUP* will limit future residential uses and playgrounds to sites that are well buffered from noise, airborne pollution, and environmental hazards.

The North End is also the location of significant portions of Newport’s and Aquidneck Island’s workforce and subsidized affordable housing. Newport is one of the few Rhode Island municipalities that exceeds the State’s minimum requirement for deed-restricted affordable housing (at 15.8%, versus the state requirement

of 10%), which makes it a low priority for receiving state housing funding. However, deed restrictions are expiring, and the proportion of deed-restricted affordable housing units in this area and citywide is declining.

Demand for affordable housing throughout Aquidneck Island far exceeds supply, leaving many families unable to afford to live in a community where they have historical, cultural and/or economic ties. The advent of short-term rentals through web platforms such as Airbnb has increased the seasonal use housing from 6% in 2010 to 13% in 2014 (*Comprehensive Plan*, 5-11) and workforce neighborhoods such as the North End have borne the brunt of the change. This loss of affordable and workforce housing has created cost pressures on housing supply and increased the number of employees who need to commute greater distances from lower-cost communities off the Island. Opportunity exists to preserve deed-restricted affordable housing and enhance workforce housing throughout the study area via development project approval processes.

# Existing Conditions Analysis

## Roadways, Transit and Pedestrian Circulation

As a result of its mid-20<sup>th</sup> century development, the existing transportation network in the North End is predominantly automobile-focused. “Superblocks” bounded by major arterials create high traffic volumes: RIDOT’s recorded average daily traffic volume for Admiral Kalbfus Road is 16,800 vehicles per day and for JT Connell Highway 14,100. A never-completed expressway divides the neighborhood and narrow collector streets and inadequate sidewalks further compound mobility and access issues. Currently, many of the roadways focus on moving motor vehicles through the North End to access the Newport Pell Bridge, the regional highway network, and attractions further south, rather than facilitating connections within the North End. Along with the Navy’s presence on the waterfront in the area, this results in the residential neighborhoods being somewhat isolated and disconnected from the waterfront, downtown, other neighborhoods, and the open space and recreational amenities within the study area.

The environment contributes to one that feels unsafe for a person travelling by any mode within the area. The current roadway network provides selected, automobile-oriented, north-south connections between the North End and the rest of the city and only one east-west connection. The straight roadway alignment on roadways, including Admiral Kalbfus Road, Girard Avenue,

and Hillside Avenue, encourage speeding and cut-through traffic. The unsignalized intersection of Admiral Kalbfus Road and Girard Avenue was specifically noted as an area of concern by participants in the engagement process for this project. In part because of its role as the lone east-west connection and its access to the Newport Pell Bridge, traffic volumes on Admiral Kalbfus Road are the second highest in the city.

Yet there are many opportunities to reshape the existing transportation network to address a number of these concerns. RIDOT is proposing an off-road multi-use pathway along Admiral Kalbfus Road with an extension northward onto JT Connell Highway and southward on the rail corridor as part of the reconstruction of the bridge approaches. The Bridge approaches project also proposes reducing the size of the current rotary to a lower speed, modern roundabout design. Roundabouts are distinct from rotaries in multiple ways, including that they more safely accommodate mobility for all users, including pedestrians and cyclists. These facilities, along with additional traffic calming strategies, will improve safety and reduce vehicle speeds, which greatly reduces the risk of a serious injury or fatality in a pedestrian crash and increases driver visibility to see other roadway users. More signalized intersections can also be added to facilitate safer roadway crossings and better manage traffic flow through transportation management systems. Finally, there are opportunities for new pedestrian and bicycle trails and greenways to break up large

block sizes as private development parcels transition in the future.

The Rhode Island Public Transit Authority (RIPTA) provides bus service to the area; however, poor pedestrian connections and lack of adequate bus stop infrastructure limit the benefit of this service to the neighborhood. RIDOT has proposed a multimodal transportation center and park-and-ride facility as part of the reconstruction of the Newport Pell Bridge approaches that has the potential to improve transit connections by creating a transportation hub, including a shuttle service from the North End to downtown. This service would be intended to intercept visitors to downtown and encourage parking in the North End with a transfer to either shuttle buses or cycling on the proposed rail trail. North End residents and employees would likewise benefit from additional shuttle service.



Current streetscape along Admiral Kalbfus Road. The infrastructure affords very little, if any, space to pedestrians, despite the road's direct connection to neighborhoods

The most recent plans for the Newport Pell Bridge approaches realignment. While RIDOT has not finalized its proposed design, it is expected that this general scheme will be adopted.



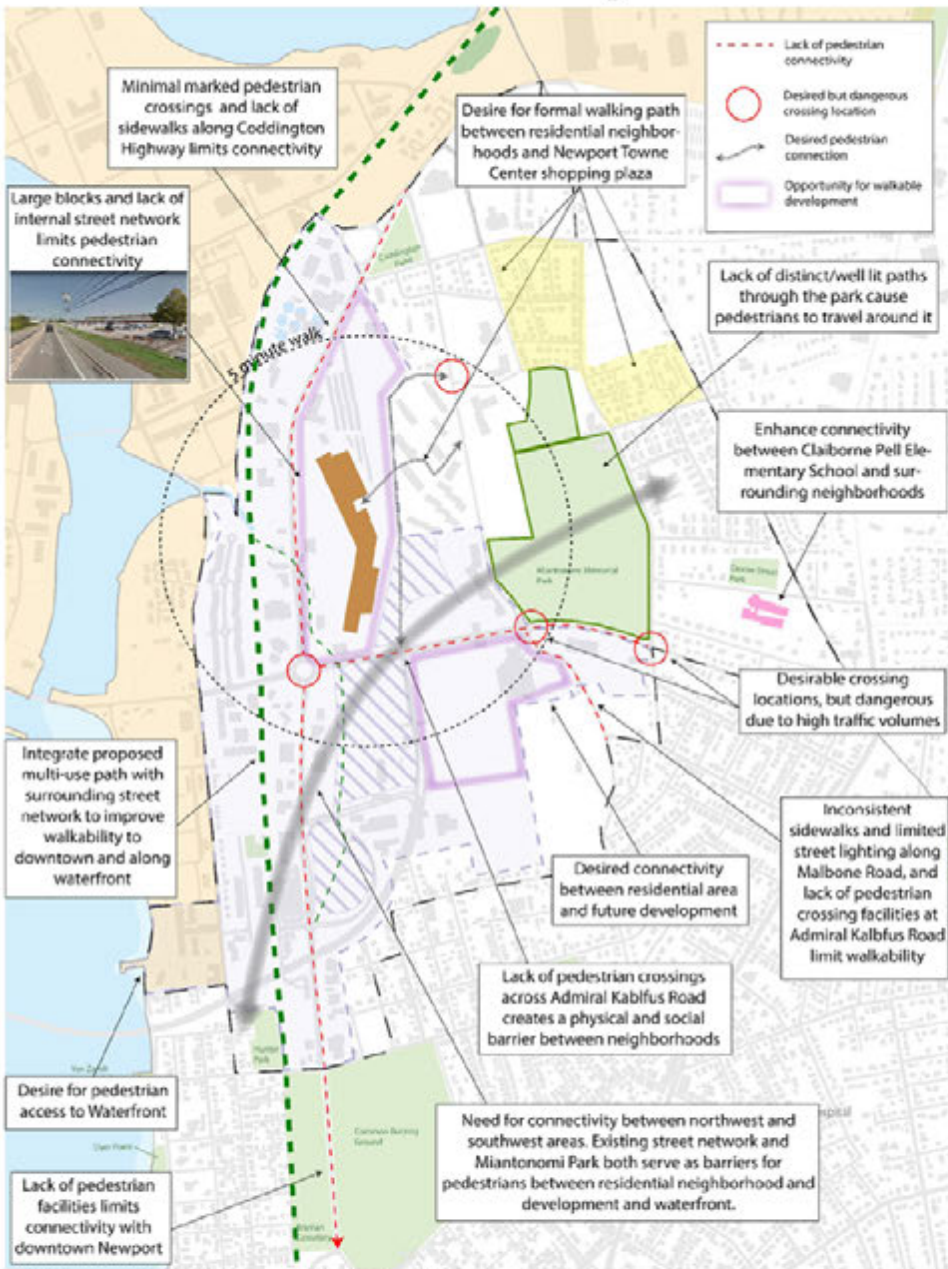

### Streets as Public Realm

- Reduce block size & increase intersection density
- Improve pedestrian connections in between blocks and neighborhoods
- Provide pedestrian links between parking, transit, and building access to promote internal site connectivity and integrate with surrounding street network
- Connect residents and commercial areas to parks, paths and waterfront to provide a safe off-street network for all ages and abilities
- Knit community together by providing safe pedestrian crossings and removing physical and psychological barriers between neighborhoods created by wide, vehicular-oriented streets

### Elements to Promote Walkability

- Require on-site pedestrian circulation and linkages through zoning code to promote connections between new development and redevelopment projects and existing neighborhoods (e.g., large development sites to residential cul-de-sacs)
- Zone for a mix of land uses to promote walking between multiple trips
- Integrate new development with surrounding street network, parking, and transit
- Integrate new development with surrounding street network
- Provide elements like pedestrian scale lighting, street trees & greenery, and branded wayfinding signage

#### Street Trees



#### Expanded Pedestrian Space



#### Wayfinding







### Expand Connectivity

- Improve safety and comfort for bicyclists with protected facilities
- Connect North End Newport with adjacent neighborhoods and communities
- Expand implementation of Complete Streets Action Plan by continuing identified improvements for Coddington Highway into the North End, including bicycle lanes, a road diet, and a separated path along Coddington Highway.
- Provide connections between street network and proposed Aquidneck Island Bike Path

### Complete Streets Aquidneck Island Improvements

				
Marked Shared Lanes	Bike Lanes/ Paved Shoulders	Shared Use Paths	Enhanced Pedestrian Crossings	Road Diets
Anthony Road (proposed)	West Main Road (North of Rl 26)	Sakons River Bridge	America's Cup Avenue	Strat Ferry Road
Boyle Lane (proposed)	Borne Road	Between Cory's Lane & Borne Road	Memorial Boulevard	West Main Road
Cory's Lane (proposed)	Coddington Highway			Coddington Highway
Coddington Highway	America's Cup Avenue			Memorial Boulevard
Memorial Boulevard	Memorial Boulevard			East Main Road

Complete Streets are road systems designed to accommodate all users to include pedestrians, bicyclists, automobiles, and transit. They are designed to balance the safety and access needs of all road users. Streets designed with this principle in mind will help create a more multi-modal street network. Complete Streets promote more livable communities. *Rhode Island Complete Streets Action Plan, 2015*

Currently Coddington Highway is the only street in the project area included in the Complete Streets Aquidneck Island Improvements.

### Improve bike connectivity by finding opportunities for...

#### On-Street Bike Facilities



#### Separated Bike Facilities



#### Off-Street Paths



#### Bike Parking



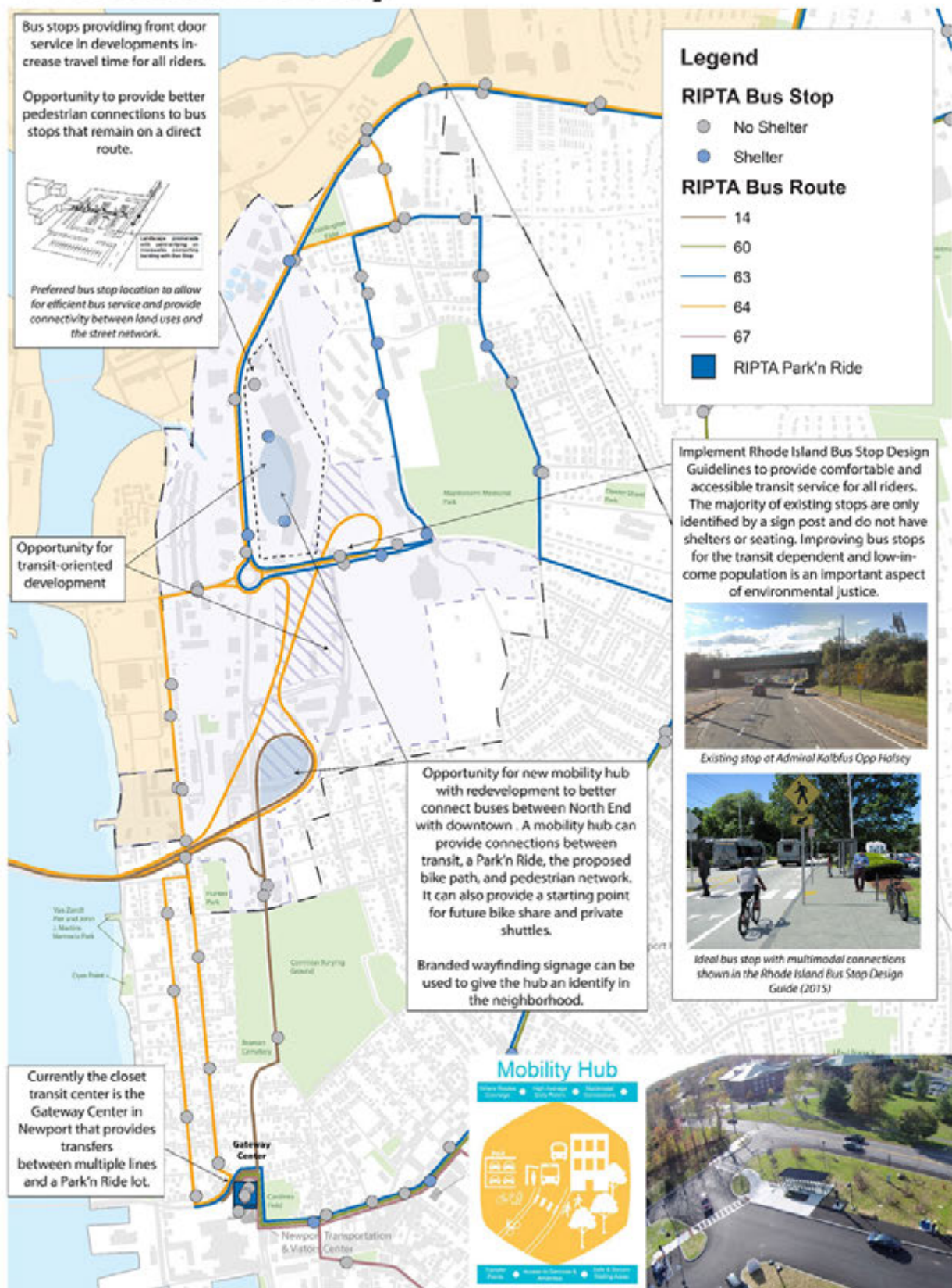

Mobility hubs are places where people can access services or amenities as they transfer between modes of transportation, such as transit, walking, bicycling, or driving. Mobility hubs are typically located where different bus routes converge, or a connection to another mode such as a Park'n Ride, offering a safe, secure waiting area, and serve areas with high average daily riders. The major features of a mobility hub are connectivity, safety and security, multimodal connections, and design and amenities. Likely locations for mobility hubs are downtowns or neighborhood centers, hospitals or medical buildings, shopping centers or malls, college campuses, and large business parks.

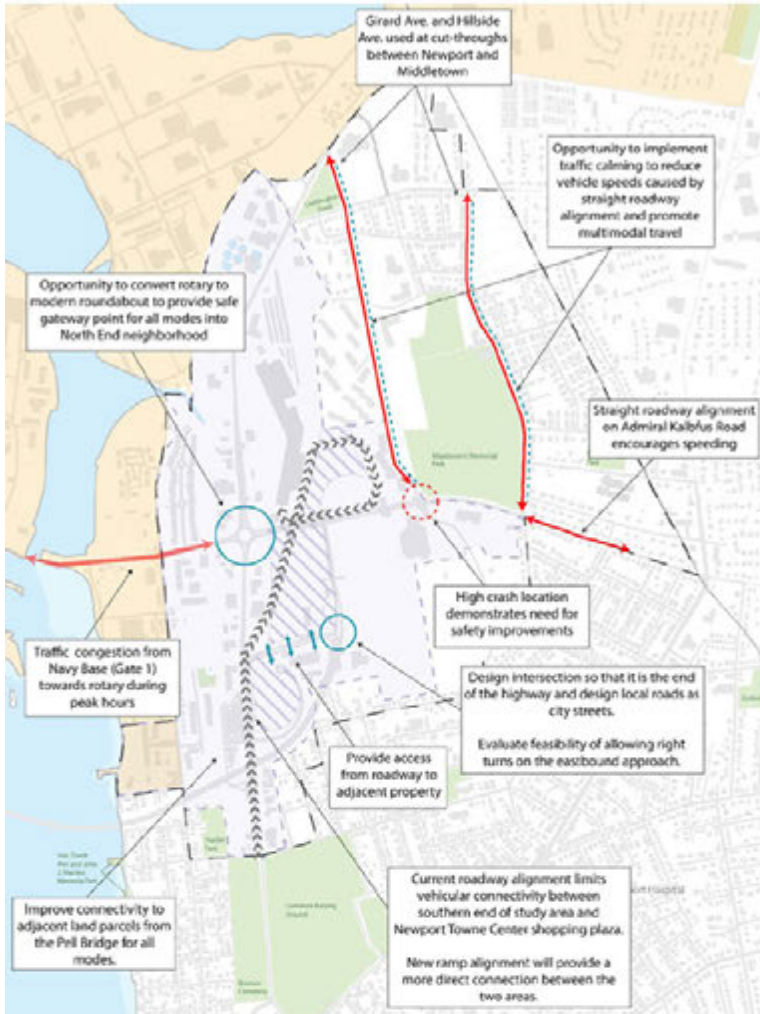

Mobility Challenges	Mobility Opportunities
Lack of interconnectivity between blocks	Reducing block size to expand street network
Commuter vs. local traffic	Potential for mobility hub to benefit residents and commuters
Auto-oriented development pattern	TDM strategies to reduce parking needs

### Rotary vs. Roundabout

Roundabouts are distinct from rotaries in multiple ways, including that they have the potential to accommodate mobility for all users. Roundabouts improve safety by:

- Slowing vehicle speeds
- Reducing the number of conflicts
- Potential crashes less severe than typical intersection due to angled and side swiped vs. head on collisions
- Allows for pedestrian and bike crossings with one direction of vehicular travel at a time
- Promoting traffic calming
- Reducing the paved surface area
- Creating more efficient traffic flow
- Geometric deflection at entry points

Roundabouts are included as a way to improve safety for all modes in the Rhode Island Complete Streets Action Plan.

### Safety and Vehicle Speed

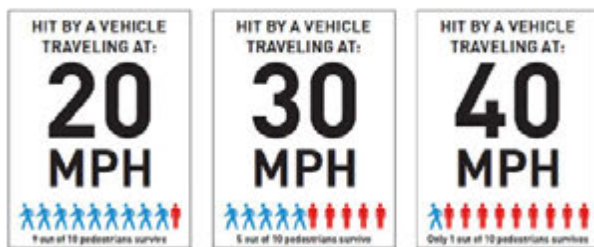

Reducing vehicle speeds greatly reduces the risk of fatality in a pedestrian crash and increases the field of vision for the driver so that they can see other road users.



Newport Rotary



West Warwick Roundabout



# Existing Conditions Analysis

## Stormwater, Sea-Level Rise, & Other Climate Hazards

The North End contains a series of small wetlands and stream beds that are remnants from its previous saltwater wetland/marsh condition prior to development. These residual wetlands create a series of potential stormwater management areas running north-south along the JT Connell Highway corridor and existing Newport Pell Bridge approaches. Currently, these degraded areas have limited storage capacity due to the narrow channel, invasive plant life, and lack of continuous basin.

Upstream of the remnant marsh areas, Elizabeth Brook (the primary watershed streambed) meanders through the study area starting uphill of the Malbone Estate east of Miantonomi Park, and heading south and then west through the site of the former incinerator and current waste transfer facility, under the former jai alai facility and the City Yard before traveling alongside JT Connell Highway to Coaster's Harbor. The existing stream corridor is either tightly channeled or culverted and passes through multiple sites, such as the former city dump and incinerator, which have tested positive for contaminated soils.

A significant portion of the study area, primarily in the low-lying areas, is prone to flooding due to surcharge of existing utility outfalls along the coastline as well as limited overland flooding during high tide storm events. The current and future flood pathway for overland flooding leads

Buildings in blue are currently at risk of flooding according to FEMA flood insurance mapping.

to the mouth of Elizabeth Brook where it meets Coaster's Harbor near the Third Street Bridge, just beyond the Naval Station Gate 2. As sea-level rise raises the height of the tides, the low-lying areas will become prone to daily nuisance flooding at high tide and severe flooding during large storm events.

In addition, several parcels in the upland neighborhoods experience ground seepage which may be caused by utility deficiencies such as main breaks, natural causes, or subsurface alterations to groundwater or culverted flow. For example, a July 15, 2020, downpour overwhelmed the culverted brook at Malbone Road and damaged the sidewalk.

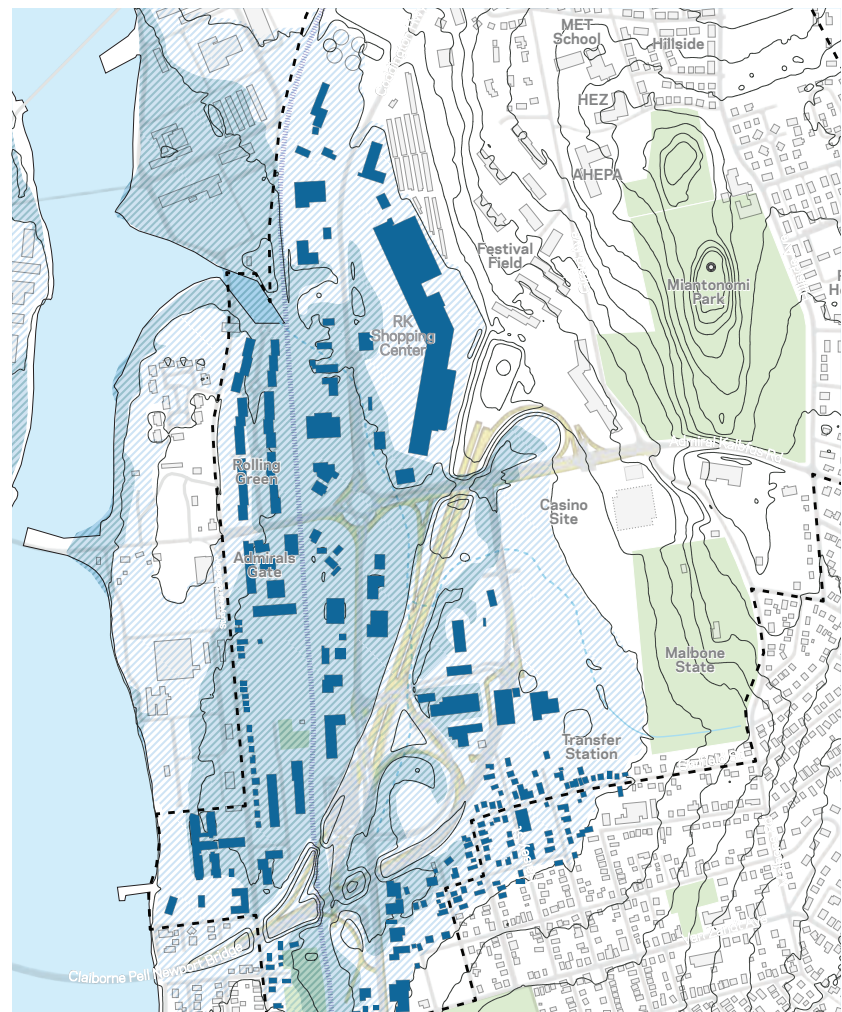

Modeled flooding with 10 feet of Sea Level Rise and a 100-year storm event.

<https://advanced-stormtools-crc-uri.hub.arcgis.com/>

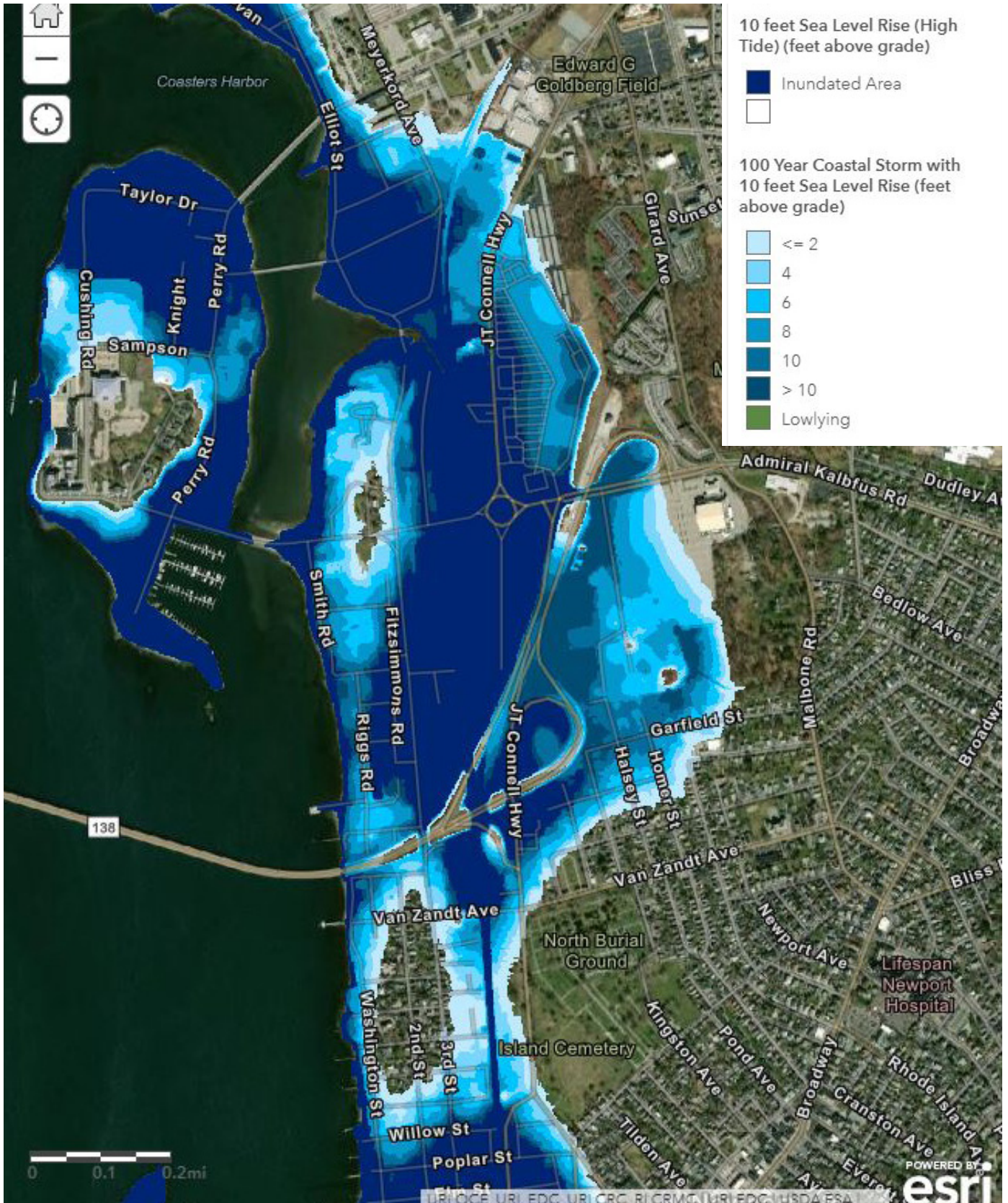

# Existing Conditions Analysis

## Open Space & Recreational Facilities

The North End has two large important open spaces, Coddington Field and Miantonomi Memorial Park. Both sites have received renewed attention for improvements in recent years: basketball courts are planned for Coddington Field, replacing one softball field, and Miantonomi Memorial Park has seen additional play areas and comfort stations added along Hillside Avenue. Despite this attention, as outlined in previous studies such as the *Tree, Parks, and Open Space Master Plan*, the North End is still lacking in both variety and quantity of active recreational open space. The North End has a high percentage of school-age children but limited recreational opportunities compared to other neighborhoods. Smaller open spaces include the Third Street Playground, Hunter Park, and Newport Dog Park (proposed to be relocated opposite Hunter Park along the RIDOT-proposed rail-and-trail).

Within the study area, there are several underutilized or vacant parcels owned by institutions, such as an 8-acre site on Hillside Avenue owned by the Newport Housing Authority (which has been designated for future public assistance housing development). These sites, while slated for future housing development, could be utilized for interim recreational, agricultural, or renewable energy production uses that can support the Green and Blue Economies.

Within the study area, nearly all of the three-plus miles of waterfront is currently inaccessible to the public. Most is restricted Naval Station Newport property, except for a sliver of land in front of private residences along Washington Street at Cypress Street and the former Navy hospital site slated for transfer to City ownership. Expanded public use of the waterfront at this location has long been proposed.

As shown in this graphic from the *Tree, Parks, and Open Space Master Plan*, the proposed multi-use path along the rail line parallel to JT Connell Highway can be shared by bicyclists and pedestrians, in a space that incorporates resiliency measurements.



Existing open space resources in the North End and surrounding neighborhoods.



# Existing Conditions Analysis

## Sustainability & Renewable Energy Opportunities

Stakeholders expressed an interest in increasing resiliency and advancing the production and use of renewable energy to support the North End, Newport, and Aquidneck Island. This could take many forms as the East Coast energy grid changes over time with the adoption of offshore wind, solar, and other renewable energy choices. Several factors influence the ability of the *NEUP* to advance the goals of producing or using more renewable energy and the more general desire for the reduction of greenhouse gasses and carbon in future development. With the state's advancing leadership in offshore wind energy, the opportunities for green electrical power have never been greater.

One challenge specific to Rhode Island is the limited ability for the municipalities to mandate energy efficiency and performance requirements beyond those set by the State of Rhode Island. As a result, any special municipal regulation of energy efficiency, greenhouse gas, or carbon emissions poses legal challenges. Voluntary programs such as the Rhode Island Stretch Code for Commercial Construction can be encouraged or incentivized through a range of mechanisms that do not violate state preemption. The City should advocate for the General Assembly to pass legislation allowing municipalities to consider material selection and energy consumption as components of a development approval process.

One of the greatest challenges to the Island is the limited and potentially vulnerable single

gas pipeline to the Island. This lack of backup energy without storage capacity complicates the development of an approach that requires backup energy in the event of shock. Natural gas is not a long-term energy solution for the Island and State policy should be altered accordingly. Regarding electricity, local hospitals, public safety facilities, and some homes have diesel-powered backup systems in place, but the Island has no existing power generation capability of its own and is thus entirely dependent upon off-island power supply. Oil sources present similar challenges.

Despite these challenges, opportunities exist to advance energy resiliency on Aquidneck Island by preparing for extreme events and the potential impact of power loss. New development should address these challenges and consider incorporating clean energy generation and islanding techniques such as energy storage to protect against unused production capacity. Eventually a system of Island-based solar and/or wind power, along with ground-sourced heat pumps and anaerobic digestion, could assist in resiliency once a more robust Island-wide power source is installed.

Despite the prohibition of mandatory stretch code or specific metrics, communities can require new development to analyze passive and active strategies that minimize GHG emissions and maximize the use of clean and renewable energy. The requirement to study such measures during project approval serves the purpose of highlighting potential strategies, provides a base case analysis and identifies choices for both the developer and the city to a more resilient future.





# Existing Conditions Analysis

## Community Resources & Equity Concerns

The North End is unique within Newport. It possesses a physical landscape unlike the rest of the city, with both a signature open space in Miantonomi Park and undistinguished 20<sup>th</sup> century strip retail, and traditional neighborhoods abutting large-scale development – residential and commercial – not seen elsewhere in the city. Likewise, the demographic landscape of the North End is also unique: there are far more families with school-age children, more residents of color, and on average median household incomes and educational attainment are lower than other Newport neighborhoods. Unfortunately, despite the evident need for access to civic amenities, housing options, and accessible employment opportunities, for example – things which may be found in abundance in some other parts of the city – the North End is often underserved.

Currently, the RK Towne Center shopping center is the primary retail area for local residents, although those businesses are difficult to reach without a car. The strip retail along JT Connell Highway, while diverging from Newport’s traditional scale and character, does provide a range of services to the rest of the city, such as boat and car sales and repair, vehicle rental, self-storage, and even dinner theater.

The study area has considerable job density both in retail and for small, production- and trades-oriented businesses at the Tradesmen’s Center and other small businesses along JT Connell Highway. However, there is growing concern that the retail jobs in the area offer limited upward mobility, while the production jobs increasingly require a degree of training not easily attained by North End residents without additional support.

The North End has the city’s largest concentration of subsidized housing. The Newport Housing Authority has devoted considerable resources to upgrade its facilities. Other subsidized housing facilities in the study area, such as Bayside, Bridgeview, and Festival Field, serve community needs. The neighborhoods in the periphery of the study area are established, with many having homes constructed in the early-to-mid-20<sup>th</sup> century. They are primarily single-family homes owner-occupied year-round. However, housing that is affordable to working households and families remains a significant challenge for many residents, including those who seek to move to the next economic level from subsidized housing, as home prices in the region continue to rise and housing supply has not kept up with demand.

Several community resources are currently located in the North End including the Florence Gray Center, which houses community-advocacy organizations such as the Newport Health Equity Zone (HEZ) and Newport Working Cities, and after-school programs. The Newport campus of the Community College of Rhode Island (CCRI), the Pell Elementary School, and the MET School are also located within the study area. However, despite the density of families in the North End, middle and high school children must travel across the city to get to those schools. The MET School’s current enrollment includes few North End residents.

During the engagement process, many North End residents described feeling isolated from the resources they needed in the city and expressed a desire to be able to safely and comfortably walk or bike or take transit to those resources, and to see more of those resources within their own neighborhood.

Input collected from February Public Forum. Participants were asked to describe issues related to equity and desired community benefits.



# Public Engagement Process

In order to support the goal of building community understanding of key issues, a robust community engagement process was undertaken throughout the research period of the project team's work.

Public engagement for the *NEUP* began on January 21<sup>st</sup>, 2020, with a slate of introductory meetings for the consultant team, including the Chamber of Commerce, community organizations, City staff, the Rhode Island Department of Transportation, and the project Steering Committee. A representative of the project team also attended the Newport City Council meeting to address the Council about the project workflow. Additional events attended included "Art with Nycole" session at the Newport Public Library, the North End Neighborhood Association meeting, Clean Ocean Access's Winter party, and a tour of Newport with the City's Communications Officer.

The following week, the project team met with representatives from Connect Greater Newport, Discover Newport, Bike Newport, Conexión Latina Newport, the City of Newport Energy and Environment Commission, the Community College of Rhode Island Newport Campus, and the presidents of the Tradesmen Centers. Mapping activity data was collected at a meeting of the Off-Broadway Neighborhood Association and community members walked the east side of Miantonomi Park and Newport Heights with a project team member to identify and photograph relevant existing conditions.

## Public Forum

February engagement culminated in a Public

Forum at the MET School on February 25th, 2020 that brought nearly 150 Newporters together to shape the *NEUP*. The consultant team was also available throughout the day on February 25th and 26th at a Drop-In Center popup event at Florence Gray Community Center, visited by dozens of Newporters. Event outreach was conducted through the City website, Newport Public Schools, an online comment portal, email, and hundreds of bilingual flyers. The engagement in preparation for that event resulted in over 340 contacts representing over 60 Newport businesses, 25 individual and 17 small group meetings, as well as 65 registered followers on the online comment portal. The project team also met directly with representatives from the Carpionato Group, The Point Association, the Women's Resource Center, the Blue Innovation Symposium, the Navy, the City's Superintendent of Parks, Grounds & Forestry, the Newport Housing Authority, the City's Bicycle and Pedestrian Advisory Committee, and the Newport Transportation Planning Committee, and conducted mapping activities with young professionals at Innovate Newport, residents of "the Swamp", the North End Neighborhood Association, and the Health Equity Zone working groups on Transportation, Housing, Green and Urban Spaces, Arts and Culture, and Food Access.

## Online Survey

After the February Public Forum, engagement continued in preparation for a second forum, which eventually morphed into the Online Survey because of COVID-19 restrictions on in-person events. Engagement between the forums

Below: The North End Urban Plan Steering Committee met for the first time on January 21, 2020. The Committee provided input on critical topics, identifying community concerns and directing the project team's work.

included conversations with the Van Beuren Charitable Foundation, the Connect Greater Newport Steering Committee meeting, a walking tour with Garfield Avenue residents, a consultant radio interview with WADK's Bruce Newbury to talk about the *NEUP* and how to participate, a youth mapping workshop with Newport residents who attend the MET School, and a mapping activity with more than 35 members of Point Association neighborhood group.

To shift the second public forum online, the project team substantially revised materials already prepared for an in-person forum and implemented a Qualtrics survey available at the online comment portal. From March 18<sup>th</sup> to May 18<sup>th</sup>, Newporters submitted 148 detailed responses to the 46-question survey, 128 of which addressed all 46 questions. The project team established an online information portal for the *NEUP* in February, which was live and regularly updated through August. When the online comment portal was archived, it had been

visited 2,124 times, leading to 179 comments from 186 followers. The project team also mailed postcards to the census tracts in the city with the lowest rates of internet access to offer access to printed materials and a phone-based conversation.

The input received through each of these engagement events and interactions has been directly incorporated into the *NEUP* whenever possible. The opinions and insights provided by Newporters have been invaluable to the development of the *NEUP* and have informed recommendations on topics such as desired land uses, bicycle and pedestrian connections, open space locations, public benefits, and height limits, among many others. The local knowledge shared with the project team during the engagement process demonstrated both depth and breadth, and allowed the project team to understand the priorities of the community in the application of best practices.





The Florence Gray Center hosted a number of engagement events for the *NEUP*. Working group mapping sessions, drop-in hours, and roundtable discussions provided Newporters with a range of opportunities to contribute to the plan's formation.

Residents took members of the project team on a neighborhood walking tour to share their experiences and identify locations of opportunity.



## Project Schedule

Discover		Dialogue		Deliver	
JAN	FEB	MAR	COVID 19	JUN	JULY
<p>Establish a Steering Committee</p> <p>Review site conditions and all documentation from prior studies</p> <p>Develop a “future existing conditions” plan</p> <p>Set up and begin holding key stakeholder meetings</p> <p>Research precedents</p> <p>Establish online information resource</p>	<p><b>Forum Week #1</b></p> <p>Small group exercises</p> <p>Begin formulating concepts</p>	<p>Verify direction from Forum Week #1 w/ Steering Committee</p> <p>Narrow options for preferred framework</p> <p>Additional coordination meetings with RIDOT, Navy, Carpiionato Group</p> <p><b>On-line Survey</b></p> <p>Begin compiling recommendations</p>	<b>COVID 19</b>	<p>Verify direction from Forum Week #2 w/ Steering Committee</p> <p>Review final products describing character &amp; quality</p> <p>Additional coordination meetings with RIDOT, Navy, Carpiionato Group</p> <p>Prepare draft plan for Steering Committee review</p>	<p>Public Hearings</p>

### NORTH END COMMUNITY OUTREACH January-August 2020

**350** individuals on our contact list, representing over

**60** Newport organizations & businesses

**25** individual meetings and phone calls with advocates & local experts

**17** Small group meetings, including 5 mapping activities attended by a total of ~100

**2,124** Visitors to our project website, making 177 comments

**7/7** City Councilors engaged in person, by phone, and via video conference

### ONLINE FORUM March 18-May 18, 2020

**148** substantially complete responses

**67%** of respondents spent more than 20 minutes answering questions

**Question Formats:**

- Ranked Preference
- Multiple Choice
- Open Response

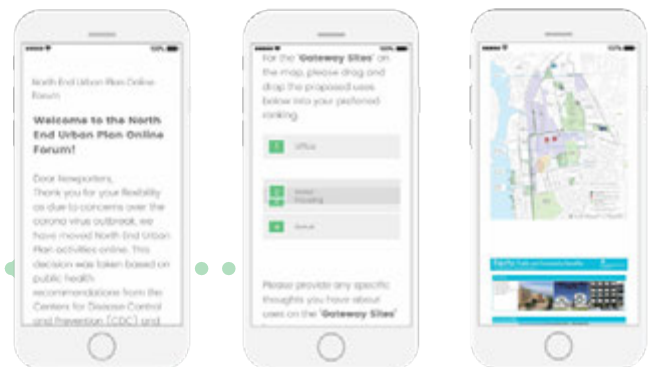

cherlich@nbbj.com  
 amartj@nbbj.com  
 eric\_golden@emerson.edu  
 johnharlow7@gmail.com

## Goals + Aspirations

- High quality of life by leveraging major projects
- Make this a year-round city
- Live-work-play — place people are excited to be
- Help Newport's businesses + families thrive
- Leave a legacy we're proud of
- Provide the things Newport residents want + need
- A true part of Newport — achieving econ. health equity — integrated w/ rest of City
- Achieve a balance between econ. opportunity + amenities, opportunity + environment, opportunity vs impacts
- Expand Blue Tech economic sector
- Zoning that reflects the city's + community's vision
- A guide for responsible development
- Physical connection improvements, esp for peds focusing on creating a human scale
- Improvement to Tradesmen's Center
- Support intermodal transit center
- Address existing community needs through private development
- Effectively involve youth throughout process
- Waterfront access for the public — waterfront walk

## Risks + Challenges

- Environmental impacts resulting from development
- Environmental impacts on development
- Impacts on surrounding neighborhoods
- Building trust in such a short period of time
- Pell Bridge plans + timeline — alignment w/ this effort
- Ability to influence proposed development
- Resilience of infrastructure — water + power
- Development that isn't reflective of local character
- Combined impacts of SLR + precip
- How to create realistic asst/requirments for public land
- Accessibility of jobs + businesses that come w/ this neighborhood
- Impacts on non-... of North End, esp. on... deployment, SLR
- Consequences of sea traffic health

## Add Resources + Stakeholders

- Mary — writing + on employee base leadership
- Save the Bay — Joe Stone?
- Theresse Ocean — RICAAC
- Grover Frigate
- Newport Library
- Boys + Girls Club — PGC
- Folly Coasters — Corporation to housing dev.
- Church Comm Housing + other aff.



# 2

## PLAN FRAMEWORK



# A Vision for 21<sup>st</sup> Century Living & Working

***“This plan shall be a bold statement for twenty-first century American living that will connect the North End with downtown Newport, healing their separation by an elevated expressway for the last half-century.”*** - NEUP Request for Proposals

The North End is envisioned as a mixed-use district focused specifically on growing year-round, innovative economic activity within the city. Those employment opportunities will be supplemented by retail, additional housing, lodging, and community amenities that create a bold statement for 21st century American living.

The North End will reflect Newport’s traditional character while setting a new standard for design within the city, both for architecture and for urban design, as well as resilient development in low-lying areas as a response to sea-level rise. Incorporating historical qualities such as smaller scale blocks into streetscapes, buildings, and open spaces will transform redeveloped areas into pieces of Newport that feel at once new and appropriate.



Furthermore, as a major gateway to the city, the North End will welcome visitors with high-quality design and amenities that communicate Newport’s spirit.



A conceptual rendering of the future of the North End, illustrating redevelopment according to the principles embodied in the *NEUP* with desired massing, scale, and character.

# Planning Themes & Principles

The following section outlines the range of physical and regulatory recommendations in five Themes with focus areas organized around the *NEUP* goals developed during the planning process. The graphics in this section are part of the regulatory framework of the *NEUP*. They assist in “build[ing] community understanding of key issues” and “providing visual guidance for developers, decision-makers and the public,” two of the core goals of the *Plan*.

## *Opportunity*

### *Diversify Economic Opportunities*

- Attract uses that bring new jobs to Newport, particularly jobs that are accessible to Newport residents and provide opportunity for growth
- Encourage a mix of supportive uses to which existing residents want and need access
- Ensure compatibility of existing and future uses

## *Connectivity*

### *Reconnect the North End*

- Support improved pedestrian and bicycle accommodations in the North End.
- Create more transportation options for visitors and residents
- Protect neighborhoods from cut-through traffic and add needed vehicular connections

## Resiliency

### Create Long-Term Resiliency & Sustainability

- Utilize stormwater infrastructure to enhance the experience of the North End
- Bring Newport's tree culture to the North End
- Expand open space and create a complete network of green spaces
- Embrace the Green Economy as a transformative sector

## Equity

### Achieve an Equitable Future

- Recognize and work to ameliorate the economic disparities between the North End and the rest of the city
- Harness private development to support the provision of community benefits in the North End
- Delineate the community's priorities to better assist developers and regulatory staff in their decision making

## Quality

### Guide Future Private Development

- Reflect Newport's architectural character while embracing cutting-edge, contemporary design
- Provide a welcoming "gateway" to the city for those arriving via the Newport Pell Bridge
- Require high-quality urban design elements

# Opportunity Illustrative Plan

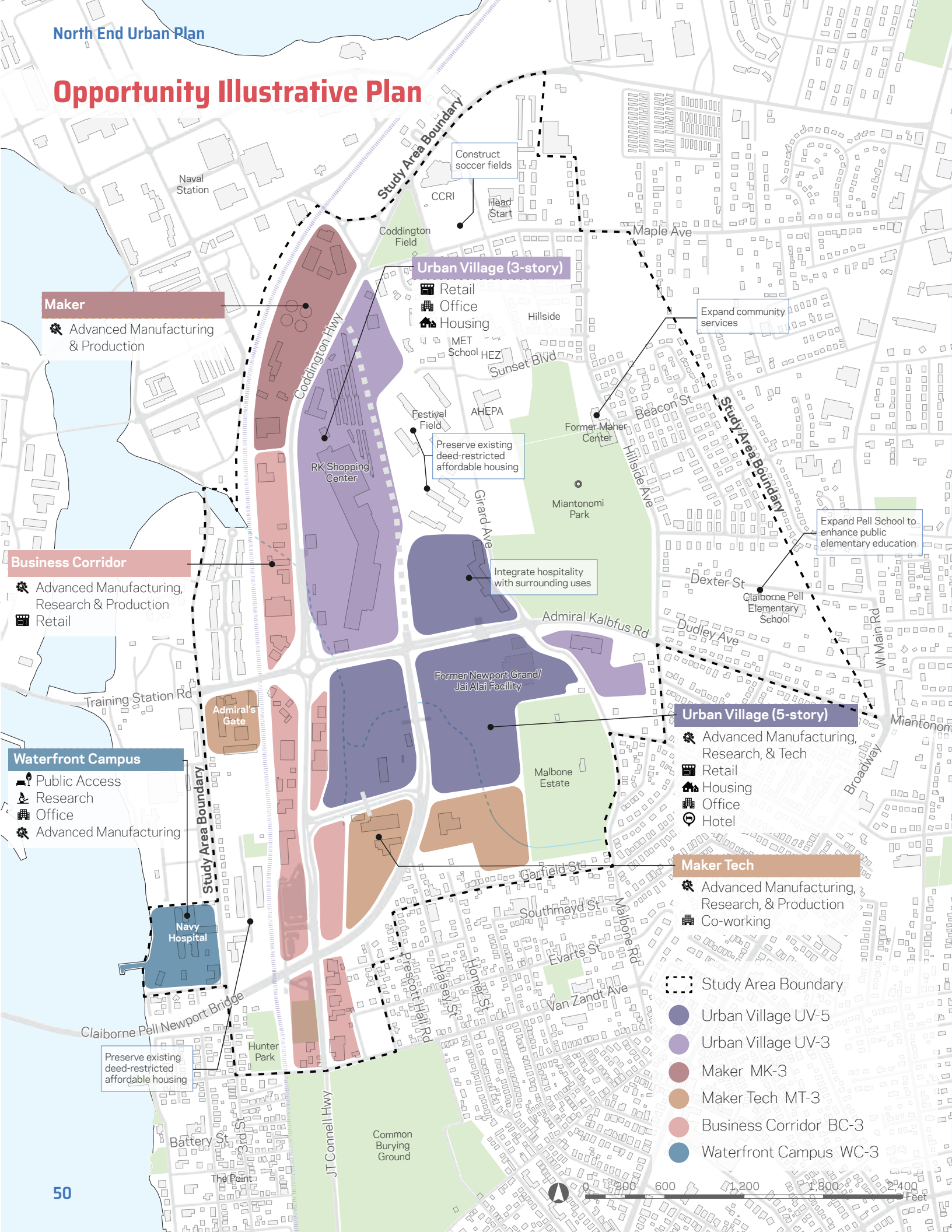

### Maker

- Advanced Manufacturing & Production

### Urban Village (3-story)

- Retail
- Office
- Housing

Preserve existing deed-restricted affordable housing

### Urban Village (5-story)

- Advanced Manufacturing, Research & Production
- Retail
- Housing
- Office
- Hotel

Former Newport Grand/ Jai Alai Facility

### Maker Tech

- Advanced Manufacturing, Research, & Production
- Co-working

### Business Corridor

- Advanced Manufacturing, Research & Production
- Retail

### Waterfront Campus

- Public Access
- Research
- Office
- Advanced Manufacturing

- Study Area Boundary
- Urban Village UV-5
- Urban Village UV-3
- Maker MK-3
- Maker Tech MT-3
- Business Corridor BC-3
- Waterfront Campus WC-3



# Opportunity

The North End is one of the last areas of Newport to be developed, and much of the area was primarily farmland until the 20<sup>th</sup> century. Naval Station Newport expanded throughout the North End before diminishing in size after World War II. In the middle of the 20<sup>th</sup> century, the wetlands of Elizabeth Brook were filled, and the incinerator was capped to allow strip style development in line with the times. This development is now widely regarded throughout the community as detrimental to the wellbeing of Newporters and in opposition to the character and quality Newporters want for their city. The existing retail uses, while important to the community for their services, provide few consistent, long-term employment opportunities.

With the reconstruction of the Newport Pell Bridge approaches, an opportunity to create a “gateway” to Newport in line with the community’s vision has been identified. This real estate opportunity will most importantly serve the economic development goal of bringing year-round jobs to the city. Additional benefits include promoting the Quality theme by creating a “bold statement for 21<sup>st</sup> century living” and enabling “diverse development amenities and street life welcoming to all Newporters”.

As described above in the Economic Background section, the current Newport economy is heavily weighted toward seasonal activity such as tourism, and this focus can limit economic diversity and thus growth and economic resiliency.

## **Attract uses that bring new jobs to Newport, particularly jobs that are accessible to Newport residents and provide opportunity for growth**

Newport has been a visitor destination since the middle of the 19<sup>th</sup> century. Agricultural and maritime industrialists and traders made way for artists before Newport reached the pinnacle of its status as a seaside resort during the Gilded Age of the late 19<sup>th</sup> century. Now a more diverse set of regional and international visitors, retirees, and “day-trippers” frequent the city at greater numbers in the warmer months. These seasonal visitors swell the population during peak months and drive demand for seasonal employment in restaurants, hotels, and cultural venues. Summer crowds have also stressed local housing by replacing year-round rentals with short-term stays. The *NEUP* is intended to assist the City in reducing such dependency on seasonal tourism by offering locations for full-time, year-round employment in higher-paying jobs based on research, finance, technology and other more diverse market sectors that provide opportunities for advancement.

As articulated in the *Comprehensive Plan*, the North End Mixed-Use, Innovation designation was intended to support new jobs in emerging high technology industries that would build on research already underway at the Naval Station and across the state. The focus was on resilience climate change, alternative energy, and defense as well as digital and financial services. This focus continues to be important.

Naval Station Newport is an economic engine and resource for the region that seeds adjacent research and development and spin-off industries. Newport can further enhance and capture the output of this economic engine. As previously mentioned, Naval Station Newport also occupies nearly all the shoreline of Narragansett Bay within the study area, though the site of the former Navy hospital is in the process of being transferred to the City for redevelopment and has water access and an existing pier at Bello Road. This site, one of the few potential public water access points, should be utilized for a range of Blue Technology uses, complementing public water access. While the definition remains broad, the site and the historic building, subject to an agreement to preserve the facades, could be repurposed for a range of public, private, or non-profit users to perform research or advocacy for the purposes stated in the *Comprehensive Plan*.

Additional businesses in the North End without direct water access can still support the Blue Economy with trades such as boatbuilding, maritime repair or maritime parts and distribution, and composites innovation. Many of these uses already exist within the study area and should coexist and support more high-tech industries that emerge in the future. To help promote the growth of high-tech industries and draw the skilled talent employers seek, the city should consider partnering with existing area universities, colleges and vocational schools to grow the talent base of Newport's population.

During the public engagement process, the

community emphasized the importance of balancing this focus with preservation of local entrepreneurs, tradesmen, and craft industries as illustrated by the job-creating uses already present in the district.

The combination will foster a wide range of job-creating uses that provide a better ladder of success for local residents. Many of the existing businesses build skills necessary to support technology businesses and places such as the Tradesmen's Center support small businesses and new entrepreneurs that currently train and teach skills in support of emerging technology. The programs already offered by Innovate Newport should be supplemented by further initiatives in the North End. Innovate Newport was intended to serve as a foothold for innovation in the north of the city, and could be a source of lessons learned and partnership.

Future zoning should be designed to ensure that the majority of new land uses are focused on job creation, while allowing limited amounts of uses that support those jobs. Allowing but limiting retail and hotel uses will ensure that the district continues to provide basic incomes and entrepreneurial opportunities to Newport residents. Complementing those uses with year-round residential housing options will ensure the vibrant mixed-use element to which the *Comprehensive Plan* strives. Development project proposals should preserve deed-restricted affordable housing and enhance workforce housing. These are both approaches supported by input received during the public engagement process.



Examples of land use types and forms suggested for the North End, based on precedent study and input from the public.

 Retail examples



 Office examples



 Housing examples



 Production/Advanced Manufacturing/Research examples



 Hotel examples



 Open Space examples



Workforce housing is typically defined by thresholds of household earnings based on area median incomes that target middle income workers. Newport's workforce is employed in positions ranging from seasonal minimum wage to highly-specialized, well-compensated positions. Workforce housing in the North End should be built to reflect the full spectrum of working persons in the city. The density opportunity in the North End allows for lower unit costs, and lower-priced housing is a community benefit. There is an especially great need in Newport for housing to provide for residents who make just above the qualification levels for subsidized housing. All residential projects should be architecturally-integrated mixed income.

### **Encourage a mix of supportive uses to which existing residents want and need access**

As was previously mentioned in relation to the *Comprehensive Plan*, the Mixed-Use, Innovation designation is intended to allow and encourage retail and housing uses in support of the primary jobs use. The RK Towne Center shopping center provides one of the primary retail centers for the North End and the larger Island region. North End residents supported retail uses in the study area and advocated for a continuation of retail in future redevelopment, coupled with improved pedestrian experience. Also clearly preferred by participants was additional housing in the North End to relieve the housing shortage in greater Newport and Aquidneck Island. Plan participants advocated for housing that would

be affordable for families who do not qualify for housing assistance programs or public housing; current residents can face a harrowing choice between long-term economic advancement and short-term housing affordability. This type of "cliff effect" housing is in short supply as prices for modest homes have risen as a result of both short-term rentals in Newport and general pressures typical of coastal cities nationwide.

Though the *NEUP* proposes general approaches to expanding limited commercial and economic opportunities into the residential areas of the North End, specific strategies should be explored in future planning efforts. The vacancy at the City-owned former Maher Center provides an opportunity for additional community services or entrepreneur support. East Bay Community Action Partnership's Health Center, CCRI Newport, the Florence Gray Center, the Met School and the Pell School provide additional community amenities and should be supported.

Uses such as hotels and conference centers can support the primary purpose of the district. Hotels that cater to more year-round business users with conference facilities can support the business purposes of the *NEUP* and *Comprehensive Plan*. Hotels should be integrated with surrounding uses and not operate as islands in the community. In addition to hotels, housing should be considered a supportive use for an active mixed-use district and as an offset to additional local employees anticipated for new businesses, and which would reduce both pressure on existing housing stock and the commute trips from off-Island.

## Ensure compatibility of existing and future uses

New housing should only be allowed in locations that would be compatible with residential uses, such as sites remote from noisy or hazardous industrial uses. For example, new housing should not be allowed in proximity to the city sewage treatment plant, waste transfer facility, heavy traffic routes or in close proximity to vehicle or boat repair yards that produce noise or fumes that could be hazardous. Within the Innovation District, housing should be a supportive use that is allowed within a mixed-use development context where sufficient buffering can allow for quality housing with access to open space and retail services. Housing should be encouraged where the Innovation District abuts existing residential districts as a transitional use that protects existing residential uses, and as part of a more urban gateway area.

The inverse is true with any future potential expansion of commercial uses into or near surrounding residential areas. Commercial or production-oriented redevelopment should be limited in proximity to the residential areas of the North End, or properly buffered by landscape or mediating land uses. These design and use controls will slowly advance the area to a more cohesive whole, better integrated with its surroundings.



# Connectivity Illustrative Plan

Extend multi-use path to Middletown

Open shoreline to public

Build path from Florence Gray Center to Towne Center

Extend multi-use path through Miantonomi Park

Extend Halsey St to Coddington Hwy

Improve pedestrian & bicycle connections to beaches

Build multi-use path through Halsey to Adm. Kalbfus

Ped. & bike connections to Broadway business district

- Study Area Boundary
- RIDOT proposed multi-use path
- Existing trail
- Existing bike trail
- Proposed new multi-use path connection
- Proposed multi-use path on existing street
- Proposed road extension
- Pedestrian-friendly intersection
- Pedestrian sidewalk improvements
- General location for new Multimodal Transportation Center



# Connectivity

Improved connection between the North End and the rest of Newport and within the North End itself are foundational goals of the *NEUP*. Though *Connectivity* is a Theme unto itself, it is impossible to fully separate from land use, resiliency, equity, and character discussions.

With the exception of the Newport Pell Bridge and its approaches, there are no streets in Newport with speed limits higher than 25 miles per hour; extending this speed limit to the Newport portion of the proposed bridge approach roads would reduce pollution and improve safety with minimal impacts on travel times.

Newport has generally small block sizes and much of the city has continuous sidewalks and a robust tree canopy. Coupled with beautiful and historic architecture and a strong retail environment, this creates one of the most pedestrian-friendly environments in the region. The North End, however, has limited sidewalks, a street network with few through-connections, few street trees, and lacks place-defining streetscape elements.

Transit and bicycle use in Newport are far below the city's potential. The North End can lead the way to make transit and cycling more attractive modes of mobility by prioritizing adequate infrastructure. The North End's suburban superblocks create speedways and crowded thoroughfares that discourage non-motorized modes; the *Plan* seeks to alleviate this issue.

The public connections outlined in this Theme are fundamental public benefits expected of any development proposal.

## Support improved pedestrian and bicycle accommodations in the North End

Additional multimodal facilities, such as greenways, bikeways and green and complete streets along key north-south corridors will better connect neighborhoods within the North End and also better link the North End to surrounding neighborhoods and beyond. Major routes from the North End into southern Newport, including Malbone Road, Broadway, and Farewell Street, lack sufficient bicycle facilities. The multi-use path proposed by RIDOT on Coddington Highway, JT Connell Highway and the rail right-of-way to the Waterfront will facilitate regional connectivity and improve recreational and economic opportunities for residents. Similarly, these types of connections can increase use of Miantonomi Park through the creation of designated, well-lit walking routes, and access through development sites to break up superblocks. For example, pedestrian and bicycle connections should be developed through the former jai alai facility or along Halsey Street, connecting to the Off-Broadway neighborhood and Broadway to the south. This will achieve some of the additional recreational opportunities desired for the North End, described in the *Tree, Parks, and Open Space Plan* and in the *NEUP*.

Admiral Kalbfus, a state road, is lined with houses from Hillside Avenue to Broadway. Extra measures should be taken to protect quality of life for these and nearby residents. Issues including noise and exhaust pollution,

should be mitigated to the best extent possible. Most importantly, traffic calming on Kalbfus is key to the success of the Plan. Through-traffic should be reduced by offering multiple options northbound off the bridge. Traffic speed and volume should be reduced in general. Safe passage across Admiral Kalbfus should be created at multiple sites. Public safety, especially for pedestrians, is of utmost concern on this road and instrumental in achieving the broad goals of connectivity, equity, opportunity and quality.

East-west bicycle and pedestrian connections are also important for better connecting the neighborhoods to the waterfront and commercial areas. By integrating the RIDOT-proposed multi-use path on Admiral Kalbfus Road with an improved street network, walkability between the North End neighborhood and North End waterfront would be dramatically enhanced. There is also a desire for east-west connectivity between residential neighborhoods and future commercial development along Admiral Kalbfus Road and to the north at the RK Towne Center shopping center. Facilitating connectivity through these commercial areas, and across JT Connell Highway, will provide greater access for residents to the waterfront to the west. A connection between Girard Avenue and the waterfront through the RK Towne Center shopping center, for example, would also enhance desired connectivity for the residents near Newport Heights.

Additional pedestrian connectivity can be achieved by reconnecting rights-of-way lost



The image at top shows the existing rotary at Admiral Kalbfus Road and JT Connell Highway. The rotary is hostile to pedestrians and out of scale with many surrounding land uses. The bottom image depicts an example alternative design for handling similar traffic patterns, creating a safer and more pedestrian-friendly intersection.

Opposite: A concept rendering of the transformation of a large shopping center in the North End, creating a more human-scale streetscape.

during the construction of the railway line, and the Newport Pell Bridge approach ramps. Streets such as Dyres Street/Dyers Gate Street once may have extended from the waterfront to JT Connell Highway, and should be restored as pedestrian rights-of-way.

According to numerous studies of transportation choices, people are unlikely to voluntarily choose walking and cycling as a mode of transportation if they do not feel safe. Several locations in the North End have been identified with conditions that make pedestrians feel unsafe; participants in both the Public Forum and the Online Survey shared personal experiences that contributed to the list of locations where such conditions exist. The minimally-marked pedestrian crossings and lack of adequate sidewalks along JT Connell

Highway and Coddington Highway, and high traffic volumes and lack of pedestrian crossing facilities along Admiral Kalbfus Road are two instances of arterials that limit connectivity to and from the North End neighborhood. Providing designated pedestrian facilities, such as wider sidewalks and crosswalks, and redesigning intersections, for example converting the existing rotary to a modern roundabout as proposed by RIDOT, can provide a safely operating intersection for all modes in the North End neighborhood. However, to emphasize the more urban nature intended for the North End, and in keeping with roadways found throughout the rest of the city, a pedestrian-friendly and more traditional signalized intersection may be desirable. In addition, a large number of intersections have been identified during public



outreach as locations that can be improved for non-motorized road users, including Admiral Kalbfus Road at Girard Avenue/Malbone Road, and crossings of JT Connell Highway.

The consulting transportation engineers that have assisted in developing this plan have studied both the public input and the existing conditions, finding that improvements may be warranted, and areas in need of improvement are highlighted in the figure as “pedestrian-friendly intersections.”

### Create more transportation options for visitors and residents

One of the biggest opportunities for improving travel within the City is the addition of a multimodal transportation center, or mobility hub, in the North End to serve both local residents and visitors. Mobility hubs are places where people can access services or amenities as they transfer between modes such as transit, walking, bicycling, motorized scooters, ridesharing, or driving. This presents the opportunity to better connect buses with other modes between the North End and downtown Newport, making it easier for both commuters to downtown and visitors who wish to travel between the two areas the option not to drive.

While the creation of a multimodal transportation center is supported by the public, the location of such a facility was the subject of much public discussion. RIDOT has proposed a simple facility between JT Connell and the rail tracks, but with improvements that could include a covered

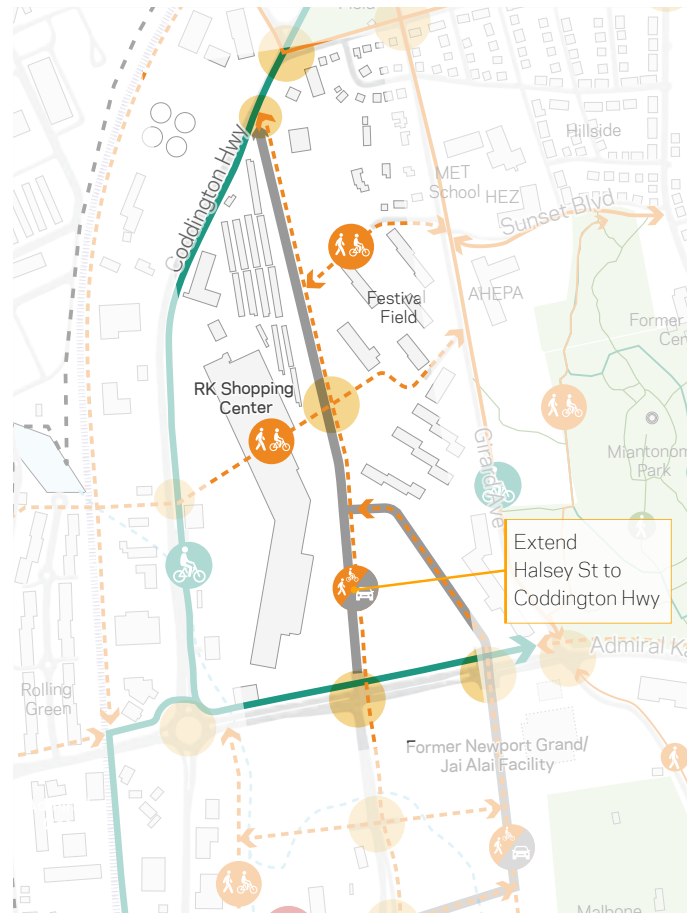

The extension of Halsey Street north from Admiral Kalbfus to Coddington Highway would improve north-south connectivity while creating opportunities for links to adjacent development.

bus station and structured parking that would support adjacent retail and commercial uses. A connection to downtown Newport could be provided with a rail or bus shuttle and bike share station. A majority of Survey respondents supported an alternative location near the base of the Newport Pell Bridge on land that will become available after the approaches reconstruction. This site would be closer to future mixed-use development at the former jai alai site and would support a greater density



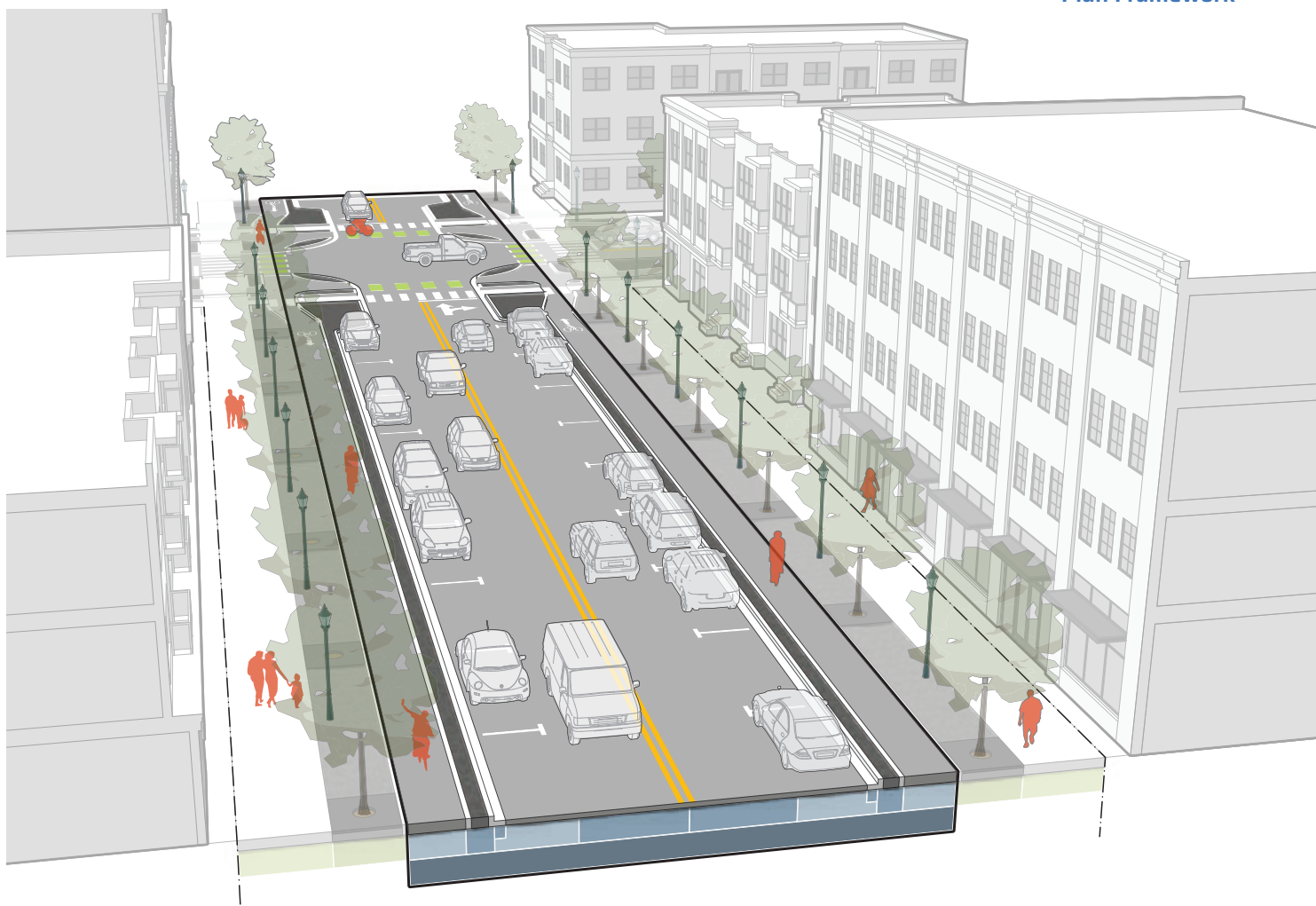

of uses within walking distance while lying somewhat further away from the rail-and-trail system.

The street network of new large-scale development must provide a hierarchy, with each street type serving specific uses, such as main thoroughfares (above) or block-breaking pedestrian alleys (below).

There is also opportunity to improve bus stops by following principles of the Rhode Island Bus Stop Design Guide, which provide recommendations for siting bus stops in relation to large-scale development and integrating bus stops with on-street bicycle facilities. Increased pedestrian, bicycle, and transit use will reduce traffic volumes on streets in the study area and reduce parking demand, freeing parcel square footage for open space or additional development. Shared parking between different uses and mixed-uses in close proximity will further reduce parking demand. Zoning for the area should be reflective of this goal.

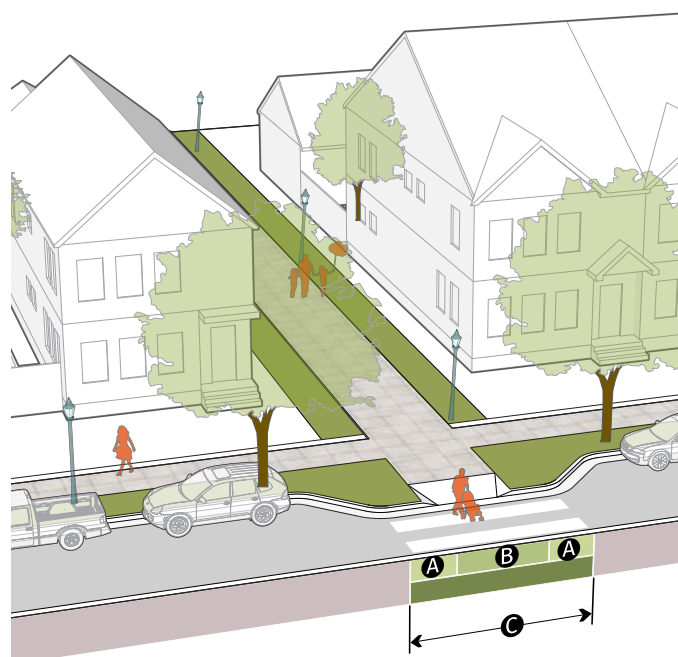

## Protect neighborhoods from cut-through traffic and add needed vehicular connections

Several local roadways, due to their alignment and limited traffic controls, incentivize cut-through traffic through North End residential neighborhoods. These streets include Girard Avenue, Hillside Avenue, and other side streets off of Admiral Kalbfus Road. Implementing recognized traffic calming strategies, such as on-street parking, street trees, chicanes, and green buffers, can help reduce vehicle speeds, making these roadways less attractive to cut-through traffic and create a safer and more comfortable experience for residents. The extension of Halsey Street from Admiral Kalbfus Road to Coddington Highway will also help to better balance the traffic demands of vehicular traffic through the North End.

RIDOT studied a northern extension of Halsey Street as part of the reconstruction of the Newport Pell Bridge approaches study but removed it from the final implementation recommendation due to concerns from the Federal Highway Administration (the funding agency) that it was beyond the scope of the proposed project. The *Plan* calls for the completion of this road segment. The benefits of extending Halsey Street to Coddington Highway include reduction of volumes at the intersection of Admiral Kalbfus Road and JT Connell Highway and along JT Connell Highway and Girard Avenue, though the potential for increased motor vehicle emissions in the immediate area would

need to be addressed. Creating this extension as an additional green and complete street would also enhance bicycle and pedestrian connectivity in an area that is largely devoid of connective streets and aid in addressing stormwater issues in the area. The green elements would reduce pollution impacts, which would be further reduced by limiting through trucking. Most of the right-of-way for an extended Halsey Street is already in public ownership or available via easement, potentially streamlining the process. At a minimum, construction of this road segment should be considered as part of any redevelopment of the RK shopping center. This road segment combined with a break in the RK Towne Center would create direct pedestrian access to the retail center from the Newport Heights neighborhoods.



# Resiliency Illustrative Plan

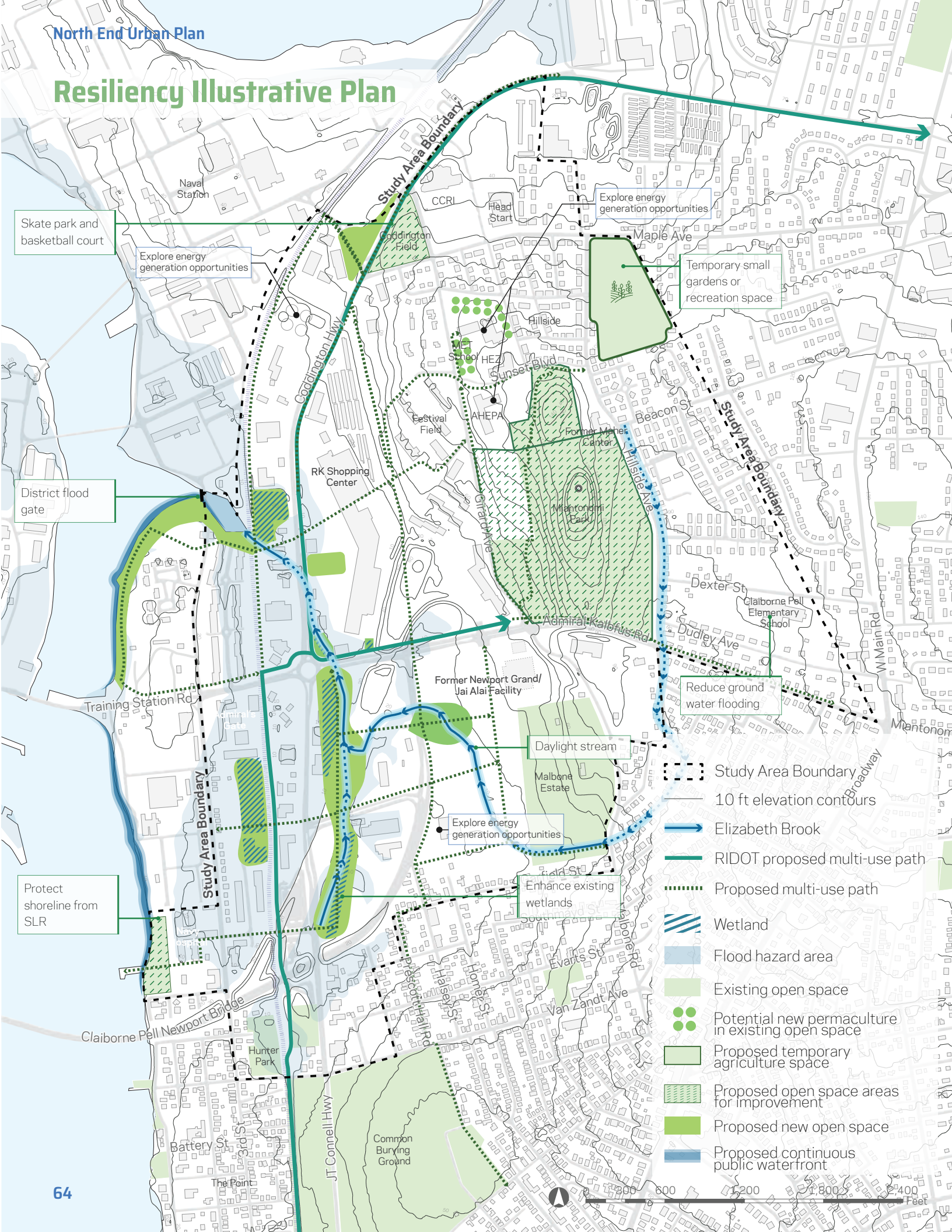

Skate park and basketball court

Explore energy generation opportunities

District flood gate

Protect shoreline from SLR

Explore energy generation opportunities

Temporary small gardens or recreation space

Reduce ground water flooding

Daylight stream

Explore energy generation opportunities

Enhance existing wetlands

Study Area Boundary

10 ft elevation contours

Elizabeth Brook

RIDOT proposed multi-use path

Proposed multi-use path

Wetland

Flood hazard area

Existing open space

Potential new permaculture in existing open space

Proposed temporary agriculture space

Proposed open space areas for improvement

Proposed new open space

Proposed continuous public waterfront

# Resiliency

The North End must incorporate cutting-edge resiliency practices, as articulated in the third Goal of this Plan. Newport enjoys unique assets which position it as a hub for resilience innovation on the East Coast. Located between New York and Boston, and a short drive from Providence, Newport is surrounded by a constellation of top tier research universities, including relevant programs such as the URI Graduate School of Oceanography, Roger Williams Law School Maritime Affairs Institute, Rhode Island School of Design, Brown University Institute for Environment and Society and Harvard's Zofnass Program for Sustainable Infrastructure, to name only a few.

A Partnership Intermediary Agreement with the Naval Undersea Warfare Center (NUWC) has laid the groundwork for access between entrepreneurs and NUWC staff and facilities, with programming offered by NUWC scientists and engineers at Innovate Newport, Newport's first innovation co-working space, located in the North End on Broadway. Additionally, Rhode Island's scale and closely-knit community make it an ideal place to model and scale projects. Development of the North End provides opportunities to highlight Newport's intrinsic assets, develop career paths for residents and create an appealing space for local families and professionals to remain. By becoming a center for resilience innovation, Newport also stands to benefit as a first adopter of innovative technology, enhancing the City's response to sea level rise and other climate change impacts.

## Utilize stormwater infrastructure to enhance the experience of the North End

Nearly all the commercial areas in the North End are subject to periodic flooding due to low elevation and surface water flows from large areas of impervious surfaces. In addition, the Elizabeth Brook, which has largely been buried, flows through the area with an outlet to Coaster's Harbor adjacent to the Naval Station's Gate 2. With the reconstruction of the Newport Pell Bridge approaches, the existing, highly-constrained wetlands areas along JT Connell Highway have the potential to expand and serve as a significant stormwater collection and infiltration area, enough to provide a large portion of the needed stormwater management/mitigation for new development if incorporated appropriately. This can be accomplished by constructing a continuous series of naturalized open spaces with a wide, shallow channel and slight modulations of topography to allow stormwater collections/infiltration combined with walking paths in upland areas for community use. This can also be supported by the design of the structures and landscape of new development.

One of the advantages of reconstructing the approaches is that excess fill from the never-completed expressway can be repositioned within the future development areas to raise building parcels out of the flood plain and leave remaining areas for added stormwater storage capacity. All new development and critical infrastructure within the "gateway" area should

therefore be raised above determined flood elevations in anticipation of future climate change and to create a unified streetscape. Successful methods of development, based on national best practices, should be emphasized here and serve as a model for development elsewhere in the city.

The Elizabeth Brook stream bed has the opportunity to serve as both stormwater mitigation as well a public amenity. This can be accomplished by daylighting the stream, widening the channel, and creating walking paths and multipurpose open space on one or both sides on development sites east of Halsey and/or leading into the north-south greenspace along the JT Connell Highway corridor. However, this would need to be reviewed against the level of contamination of existing soils and the topographic change between the bottom of the stream bed and adjacent finish grade. Sufficient space will be needed in relationship to the adjacent proposed street grid to create a welcoming public amenity, particularly if the brook is far below grade.

In conjunction with local and regional resiliency plans, a series of simple adaptations can reduce the threat of both nuisance and storm flooding associated with climate change and sea-level rise. Adding tide gates to all existing storm and combined sewer outfalls along the waterfront will help eliminate storm surcharge in the existing subsurface system. In addition, small levees can be incorporated along the channel and the open space network along the JT Connell corridor to reduce nuisance flooding during

minor high tide storm events in the near future. Finally, a taller operable tide gate (at predicted 2070 sea-level rise storm elevations) should be installed into a redesigned Third Street Elizabeth Brook bridge to be deployed during severe storm events.

It should be noted that these significant changes are only part of a larger system of stormwater management practices. In addition to district approaches, each development project must implement individual site stormwater mitigation (using low-impact development strategies) and provide improvements to the existing subsurface drainage system as part of their baseline project requirements.



## Bring Newport's tree culture to the North End

Well-established research has demonstrated tree canopy in urban areas provides a simple and long-lasting opportunity to reduce the urban heat island effect, provide cleaner air quality and provide critical wildlife habitat. The *Tree, Parks, and Open Space Plan* endorsed by the City Council institutionalizes Newport's tree culture and creates a framework for expanding Newport's already impressive urban forest. A healthy tree canopy should be created in multiple ways, each of equal importance. The first is protecting existing tree canopy with a tree protection policy that reduces the number of significant trees removed and sets in place a

policy for replacement; a good tree protection ordinance in Newport exists already. Second is to create robust tree ways (green spaces between the street curb and the sidewalk), with adequate soil volume, along new infrastructure projects, both transportation and open space. Finally, any new development should be required to plant groupings of large shade trees with adequate soil volume. This can be further refined as the City establishes its tree canopy target.

A variety of tree species and the introduction of smaller flowering/fruited trees will create a more diverse opportunity for wildlife habitat and protect the area tree canopy from devastation from a single disease or pest.

The conceptual rendering illustrates the importance of a proposed network of open spaces in the North End.



## Expand open space and create a complete network of green spaces

New development and redevelopment can provide much-needed community open space for residents, employees, and visitors. This can be accomplished by requiring development projects over a specific size to provide a minimum percentage of the overall site as open space. The plan guidelines propose a minimum 5% open space requirement on all projects seeking rezoning within the North End. Furthermore, the *Tree, Parks, and Open Space Plan* provides guidance as to the types of open space to ensure a variety of scale and program from the community benefits outlined in the *Equity Theme*.

There are additional opportunities for activities in underutilized spaces. Community agriculture, such as temporary community gardens, as well as more long term solutions like permaculture or urban greenhouses, provide an opportunity to make use of the underutilized front and side yards of various institutions, such as the Boys and Girls Club and the MET School, and the vacant land of the Newport Housing Authority, where several publicly owned larger parcels are currently vacant and awaiting long term housing development. These community agriculture programs have several strong supporters and local organizations that could help manage a variety of different garden types, which not only produce valuable food but also educate and foster community.

## Embrace the Green Economy as a transformative sector

The Green Economy, defined by the United Nations as low-carbon, resource efficient, and socially inclusive economic activity, is an important tool to combat climate change. Existing underutilized spaces and newly-created spaces can support such activity, whether by making use of building roofs for stormwater management or renewable energy generation or by providing highly-efficient design practices. Development is one of the biggest emissions sectors and new development in the North End should minimize its impact on the environment. These approaches should be further supported by jobs programs to train area residents in renewable energy and other green industries.



Below: *The Tree, Parks, and Open Space Master Plan* outlined the critical needs for the North End. Future investment in resiliency and open space infrastructure and amenities should consult this list for guidance on priorities.

## CHECKLIST FOR NORTHERN NEWPORT NEEDS\*

Future planning and development in Northern Newport neighborhoods should work to meet these critical needs:

- 30 acres of neighborhood parks
- Waterfront access
- 2-3 playgrounds
- 2 basketball courts
- 2 soccer fields
- 1 baseball field
- 1-2 tennis courts
- Additional picnic tables and gathering spaces, including 2-3 covered picnic structures
- Splash pad
- Community gardens
- Wildlife habitat protection and viewing and environmental education programs
- Increasing active transportation throughout the neighborhood
- Safe bicycling and walking connections with the rest of Newport
- Safer sidewalks/connected sidewalk network

\*Source: Master Plan Needs Assessment, with input from Health Equity Zone survey & Master Plan meetings, survey, and subcommittees



# Equity Illustrative Plan

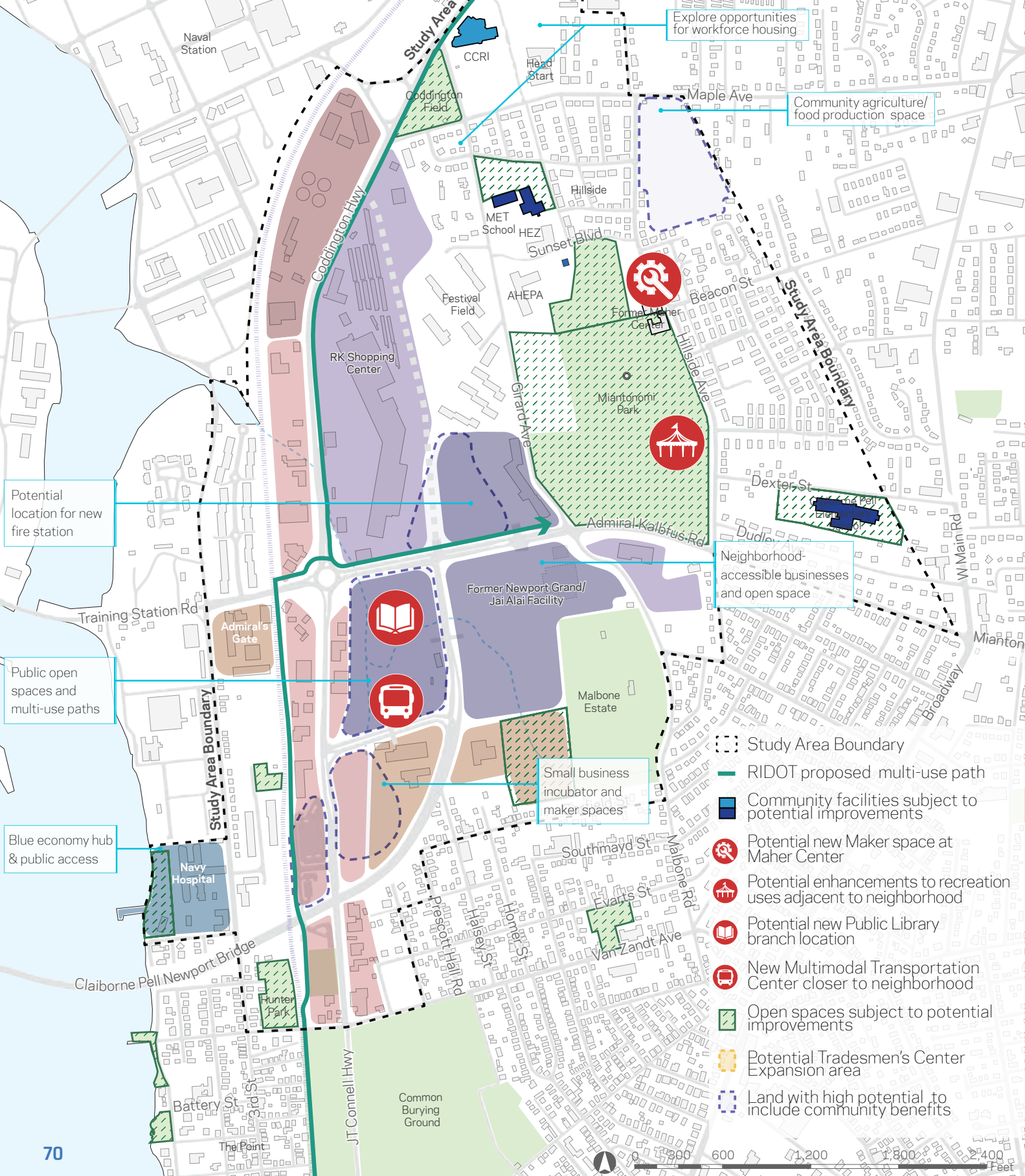

Potential location for new fire station

Public open spaces and multi-use paths

Blue economy hub & public access

Explore opportunities for workforce housing

Community agriculture/food production space

Neighborhood-accessible businesses and open space

Small business incubator and maker spaces

- Study Area Boundary
- RIDOT proposed multi-use path
- Community facilities subject to potential improvements
- Potential new Maker space at Maher Center
- Potential enhancements to recreation uses adjacent to neighborhood
- Potential new Public Library branch location
- New Multimodal Transportation Center closer to neighborhood
- Open spaces subject to potential improvements
- Potential Tradesmen's Center Expansion area
- Land with high potential to include community benefits

# Equity

Equity has been a topic of great importance to many of the stakeholders and residents who have shared their experiences and insights during the planning process. This is not unexpected, given the potential impacts of development on the existing community in the North End and the already significant differences in wealth, income, environmental quality, and opportunity between the north and south sides of the city.

One of the goals of the *NEUP* is to “reconnect the North End to the rest of Newport,” physically, as described by the *Connectivity* Theme, but also economically and socially. Considering the all-encompassing nature of equity, all of the project goals must consider their relationship to this Theme.

If executed poorly, new development could further entrench isolation and inequality of opportunity. However, new development can also be a chance to improve the lives of North End community members in meaningful ways, by providing local and accessible civic amenities, housing opportunities, recreational amenities, employment during construction and operation, and entrepreneurial and small business support.

## Protect Existing Neighborhoods

While the North End Urban Plan takes active measures to promote equity through improved civic amenity and public benefit, the desired economic development is likely to increase displacement pressures on low and moderate-income persons in the surrounding residential neighborhoods. This Plan works to protect the residents in and around the study area through preventing loss of housing stock by maintaining

the existing residential zoning, by preserving deed-restricted affordable housing, and by allowing an increase in the number of housing units through future zoning. But the City should continuously work to develop an understanding of the factors that contribute to displacement and should create solutions to maintain neighborhood stability. Such solutions may include taxation measures, zoning amendments, community benefits and other development incentives.

## Recognize and work to ameliorate the economic disparities between the North End and the rest of the city

Demographically and economically, the residents of the North End face a number of disadvantages compared to many of the other neighborhoods in Newport. Any development proposal for the North End must acknowledge these conditions and work to mitigate educational, wealth, opportunity, and geophysical disparities. All future development must actively work to incorporate North End residents, both in process and in execution, to ensure that their needs are being recognized and addressed to overcome a history of exclusion.

Development project proponents are encouraged to meet with stakeholders, local neighborhood community leaders and residents (like those mentioned in the Public Engagement Process section of this document) who may be both directly and indirectly impacted by a project, before they even program or develop the conceptual design.

## Harness private development to support the provision of community benefits in the North End

Often, developers do not fully understand the context in which they plan to build and thus cannot adequately direct their investment to best serve their own economic interests and support the local community. The *NEUP* helps provide the guidance needed to enhance the quality of a development both for the developer and for the community. While there are a number of existing tools to compel potential developers to provide community benefits, even describing them can help clarify needs and save undue headaches for potential development projects.

In addition to the other four Themes of the *NEUP* (which fundamentally identify benefits to the community), there are four types of community benefits identified as critical to meeting the needs of the community. During the course of the public engagement process for the *Plan*, both during the in-person Public Forum and the virtual Online Survey, Newporters described their preferences for the four types of community benefits described here. All components are listed below in order of preference of Survey respondents.

## Civic Amenities

As one of the more recently built parts of Newport, the North End currently has very few of the civic amenities found elsewhere in the city. However, residents of the North End expressed a need for such uses, including a farmers' market, a community kitchen, a library branch, performance spaces, public technology/computer access points, and a community center. While not all of these uses are economically sustainable on their own, development could accommodate space for many of them at a minimal cost, while others could be achieved through public-private partnership. Furthermore, by simply opening typical development amenities to the public and actively welcoming the neighborhood, many of these desires can be met. Additionally, Fire Station 1 needs to be relocated and a location out of the flood plain in the North End would better serve the community.

## Housing Opportunities

It is impossible to ignore the challenges Newport faces when it comes to housing. The most critical concern expressed by the public during the planning process was the problem

### Online Forum

### Equity Section Survey Results

"Please drag and drop the proposed community benefit CATEGORIES below into your preferred ranking."

Use	Preference
Civic Amenities	1
Housing Opportunities	2
Recreational Uses	3
Entrepreneurial & Small Business	4

of the “cliff effect”: the fact that families often face hardship due to evaporating access to subsidies for housing as their income increases, making families choose between housing or economic advancement. Furthermore, the general increase in housing prices across the city has put pressure on workforce households by making it difficult to live within the city. New subsidy structures for affordable housing and employment, and development that incorporates family housing configurations, micro-units, and senior housing are all housing options that can help address these challenges.

### Recreational Amenities

The North End possesses some of the most important protected passive open space in Newport in Miantonomi Park, but few other recreational activities are available. In a neighborhood that is full of families, with the majority of children in the city living in the North End (according to the US Census 2014-2018 5-year estimate), this is a serious community need. Playgrounds, a public marina, basketball courts, an indoor recreation center, climbing walls, open-air fitness areas, walking paths, a skating rink (seasonal or permanent), and a skate park are all amenities for which the public has expressed a desire. Additional soccer fields are a community interest but it is unlikely space for such a facility exists in the North End, except for the CCRI campus, the former incinerator site, or any future Navy dispositions. Creation of recreational opportunities and open spaces should be done in accordance with the process outlined in the *Tree, Parks, and Open Space Plan*. Further investments should be made in Miantonomi Park, in accordance with the 2018 *Miantonomi Park Interpretive Plan*.

### Entrepreneurial & Small Business Support

Since economic opportunity for North End residents is a significant need and new jobs in Newport typically fall either at the very high end, requiring extensive education, or at the low end, providing limited chance for advancement, support for entrepreneurial activities and local small business can help fill the gap. Incubators can provide shared resources and guidance for many small and startup businesses; maker spaces can give those interested in creative, technical, and vocational careers access to new skills and technologies; and low-rent or subsidized retail spaces can serve as low-barrier brick-and-mortar entry points for small retail businesses looking to test concepts and learn. CCRI and other educational institutions in the area can further advance residents’ skills and talents to integrate them into higher wage workforces. Infrastructure to facilitate mobile business establishments also presents opportunities for low-cost business operation.

### Delineate the community’s priorities to better assist developers and city staff in their decision making

By describing these priorities and the order of importance, both private developers and City and State permitting authorities can better understand how to measure the benefits proposed by the development project. While each potential project is unique, the community’s needs will likely remain relatively consistent in the near and medium terms, and the description of benefits allows the public, City and State officials, and project proponents to work from a common understanding of priorities.









# Quality

Much of Newport's most significant architecture dates from the 18<sup>th</sup> and 19<sup>th</sup> century. It includes one of the nation's largest collections of colonial buildings and several fine examples of architectural masterpieces. The North End, by contrast, is predominantly from the second half of the last century and has little to offer in the way of exemplary architecture and is even more challenged when it comes to urban design. This is unfortunately not atypical of 20<sup>th</sup> century environments, and righting this wrong is a core purpose of this planning effort. The inclusion of *Quality* as a Theme of the *NEUP* not only recognizes that trait as a paramount goal for planning, but also draws attention to the lack of quality urban environment that exists broadly in the North End, an often-underserved community.

Recent efforts have been undertaken with varying degrees of success, such as the CCRI Newport campus, the MET School East Bay

Washington Square typifies many of the traditional development patterns within the city, which were built during the 18<sup>th</sup> and 19<sup>th</sup> centuries.

Campus, HOPE VI, and the reconstructions at Park Holm and Pell Elementary School. The former Newport Daily News building is an interesting example of midcentury modern design and Admiral's Gate is perhaps the city's most prominent example of postmodern architecture. The former Navy hospital presents a fine opportunity for historic rehabilitation of its early-20<sup>th</sup> century façade and good examples of vernacular homes dot the study area. The potential for additional, large-scale redevelopment brings urgency to the establishment of clear design principles, guidelines, and precedents.

## Reflect Newport's architectural character while embracing cutting-edge, contemporary design

In the past, new structures in Newport reflected, or even advanced, contemporary design. City-colonial architecture in America is typified by Newport, as is the seaside mansion ("cottage"),





Thames Street's mixed use and active street frontages were highlighted by residents as highly desirable for the North End's future.

and Newport holds the distinction of being the birthplace of the shingle style. Preserving this architecture is of critical importance and Newport has been a national leader in historic preservation for more than a half-century. The North End, however, presents an opportunity for a fresh approach, given the increasing awareness of the inhospitality of commercial strip development, automobile infrastructure, large-scale industry, and superblocks. The North End must embrace traditional urban design coupled with architecture and construction that is reflective of contemporary culture and lifestyles, while advancing the City's commitments to inclusivity, sense of place, quality of life, and innovation.

The images within the *Quality* Theme are intended to set the stage for architectural possibility. It is up to the creativity and freedom of expression of the designer and development



The North End's main streets currently offer little in the way of character or charm, by comparison to the rest of the city.

proponent to determine what is ultimately proposed. It is the responsibility of the City to encourage creativity and active street life within the community, and to set performance standards.

New structures should employ high-efficiency techniques, such as daylighting, passive heating and cooling, flexible indoor/outdoor space, and on-site energy generation; many of these features can also be found in pre-20<sup>th</sup> century structures throughout the city. These design elements should be incorporated into the design of structures, to create an architecture reflective of its purpose and of the area's innovative spirit.

Newport has numerous examples of beautiful, functional architecture from which to take inspiration. Thames Street and Washington Square, for example, are local precedents for the desired "look and feel" – particularly with respect to scale, streetscape, and use mix – of

the Innovation District. New structures in the North End should not feel completely foreign to the context of Newport and, at an absolute minimum, must be appropriate for Newport's future climate, 30-50 years from now.

While much of Newport's building stock is residential, future commercial and mixed-use development in the North End should consider the limited, but worthy, commercial architecture that exists in Newport along Thames Street. In particular, the continuous line of storefronts on both sides of the street provide a range of articulation and transparency that is essential for successful pedestrian-oriented retail. The range of one- to three- or four-story buildings of limited frontage along a narrow right-of-way provides architectural diversity and variety of scale. The North End's wider streets require consistent building heights of at least 2-3 stories to maintain a defined street edge. The existing commercial architecture of the North End – extra-large footprints, few building entrances, little-to-no variety of scale or

articulation of detail – does not reflect the vision for the future of the North End.

Materials can also have an impact. Because the North End is envisioned as a locale for innovative uses, a more eclectic range of materials could be allowed that reflect a more playful and contemporary environment. Here, the use of industrial materials, metal siding or composite panels for example, could be deployed in ways that may not be acceptable in more historically consistent areas. A local example of this may be found in the Newport Craft Brewery, which utilizes an industrial aesthetic in an appropriate and welcoming manner.

Mixed-use residential architecture can be modern in detailing, while still maintaining the texture of historic Newport architecture. Use of vertical bay windows, roof elements and a mix of traditional materials, such as brick combined with some newer materials, creates a bridge from historic to contemporary.

The MET School (left) and the former Newport Daily News building (right) are two examples of late 20<sup>th</sup> and early 21<sup>st</sup> century architecture which provide some uniqueness within the North End.





The North End's industrial character is reflected in positive examples of recent design, including the East Bay Family Health Care center (left) and Newport Craft Brewing (right)

Larger commercial buildings that support higher technology workspaces with the need for more light can still maintain texture and character that borrows from historic elements. Here the use of steel and clear glass with floor delineations provides a sense of scale to the building. Use of some traditional materials provides continuity from historic precedents. Other elements that make this example acceptable is clear demarcation of building entrance areas and an active ground level with plenty of transparency.

### **Provide a welcoming gateway to the city for those arriving via the Newport Pell Bridge**

The Newport Pell Bridge approaches are the gateway to Newport but have long been an eyesore both for visitors and for residents of Newport. The ramps and loops were originally intended to be part of a larger expressway network heading south into downtown Newport

and north to Fall River; however, that network was never built, and its remnants are disruptive and out of scale. The reconstruction of the Newport Pell Bridge approaches provides a timely opportunity for recasting the entrance experience. Still, the challenges remain that significant traffic volumes will pass through the area, and the existing unsightly uses in the vicinity, such as the City Yard. The privately-owned and -operated waste transfer facility is on the former site of the incinerator, which was built before the Newport Pell Bridge. The transfer facility should ultimately relocate to another spot within the city that has improved truck access and less direct impact on residential neighborhoods; this would provide additional opportunities for redevelopment and north-south connections.

With the remaining lands left over from reconstruction of the bridge approaches and the former jai alai facility, over 50 acres become

available for complete redevelopment. The scale of development, and more importantly the scale of streets and blocks, must transform what has been an expressway and vehicle-dominated, ugly landscape with often-noxious uses into one that provides a worthy first impression of Newport with appropriate landscaping and a more village-like atmosphere that acquaints visitors with Newport's pedestrian-centric fabric. These parcels should be subject to more strenuous design controls than less prominent areas with less opportunity for new block configurations.

To this end, the City should advance new architectural excellence in the North End through the creation of a design review body. This group should identify, organize, and provide source imagery guidance to developers' architects. This body will make recommendation to developers by providing advice to the Director of Planning and Economic Development beginning at the

pre-application phase. This will promote the Quality goals in the Plan and continue Newport's tradition of supporting innovative architectural ideas.

### Require high-quality urban design elements

The North End was initially platted for large-scale industrial and strip commercial purposes, and later overlaid with expressway infrastructure. Existing roadways are primarily arterials (such as JT Connell Highway and Admiral Kalbfus Road), with smaller local streets that often do not connect with each other. To reconnect this area to its adjacent neighborhoods and encourage pedestrian movement, a smaller network of green and complete streets and paths should be introduced. This shall be achieved through public projects and as a condition of development

The North End can learn from adaptive reuse projects within Newport. The IYRS School of Technology & Trades facility (left) and Innovate Newport (right) are two such examples.



project approval, and should include generous sidewalks with wide pedestrian zones, planting areas and shade trees, and frequent street furniture, such as benches and restaurant seating. Limits to block size should be established on sites that are sufficiently large to require internal streets and should reflect the scale of blocks in Newport – block lengths of 200 to 400 ft.

Newport is largely a low-rise city with a mix of 18<sup>th</sup> and 19<sup>th</sup> development patterns. Because views of Miantonomi Tower, Narragansett Bay and the Newport Pell Bridge are important to the community, future development within the North End should limit heights of buildings to 5 stories. These heights should be allowed only in the mixed-use development areas at the gateway, while 3 stories should be the maximum height in the remainder of the North End. The greater height at the gateway serves to establish it as the primary mixed-use subdistrict and encourage a higher density of residential, office and retail uses in close proximity to create a walkable environment. Redevelopment of the existing RK shopping center should be limited to 3 stories with the potential to increase up to 5 stories with site plan review and additional public benefits.

Minimum heights of two stories are also desired to ensure that sufficient definition is provided along street edges and to prevent low rise, suburban-style sprawl. Redevelopment should also provide a variety of heights to promote architectural variety and avoid uniformity. Buildings of different numbers of stories can and should be placed next to each other, and floor-to-



Residential uses frequently require new forms when considered at higher densities. Newport Heights replaced military housing with traditional single and multi-family housing, effectively using traditional forms from the region.

Developing housing at higher densities that is compatible with Newport's residential architectural character can be more challenging. Examples of infill development in Providence suggest that borrowing various residential typologies such as roof forms and rhythmic breaks in street edge can help to break down the large mass and integrate larger projects into a neighborhood.



floor heights can and should vary across different use types, to create visual interest.

Along major arterials, like JT Connell Highway and Admiral Kalbfus Road, auto-oriented development patterns can be, over time, rebalanced to encourage more pedestrian activity by placing limits on both the number and width of curb cuts, reducing building setbacks and prohibiting parking along street frontages, while encouraging on-street parking. Investments in pedestrian accommodations will include ample sidewalks, multi-use paths and adequate landscape buffers and trees for protecting pedestrians from heat, traffic and piled snow. Private development must also make use of these techniques.

Mixed-use residential architecture can be modern in detailing while still maintaining the texture of historic Newport architecture. Use of vertical bay windows, roof elements and a mix of traditional materials such as brick combined with some newer materials creates a bridge from historic to contemporary.



In areas where new streets are needed or 1R-type repavings are proposed, green and complete streets will encourage walking and cycling and improve public health and safety and community welfare in an area that is currently challenging and frequently unattractive, isolating, and potentially dangerous. Green and complete streets will provide connections through and between parcels and ultimately connect residential neighborhoods to community services and public open spaces, especially the waterfront. Some of these improvements may be funded by developers as conditions of project approval.

Larger commercial buildings that support higher technology work spaces with the need for more light can still maintain texture and character that borrows from historic elements. Here the use of steel and clear glass with floor delineations provides a sense of scale to the building. Use of some traditional materials provides continuity from historic precedents. Other elements that make this example acceptable are clear demarcation of building entrance areas and an active ground level with plenty of transparency.







# 3

## INNOVATION CHARACTER SUBDISTRICTS & DESIGN GUIDELINES









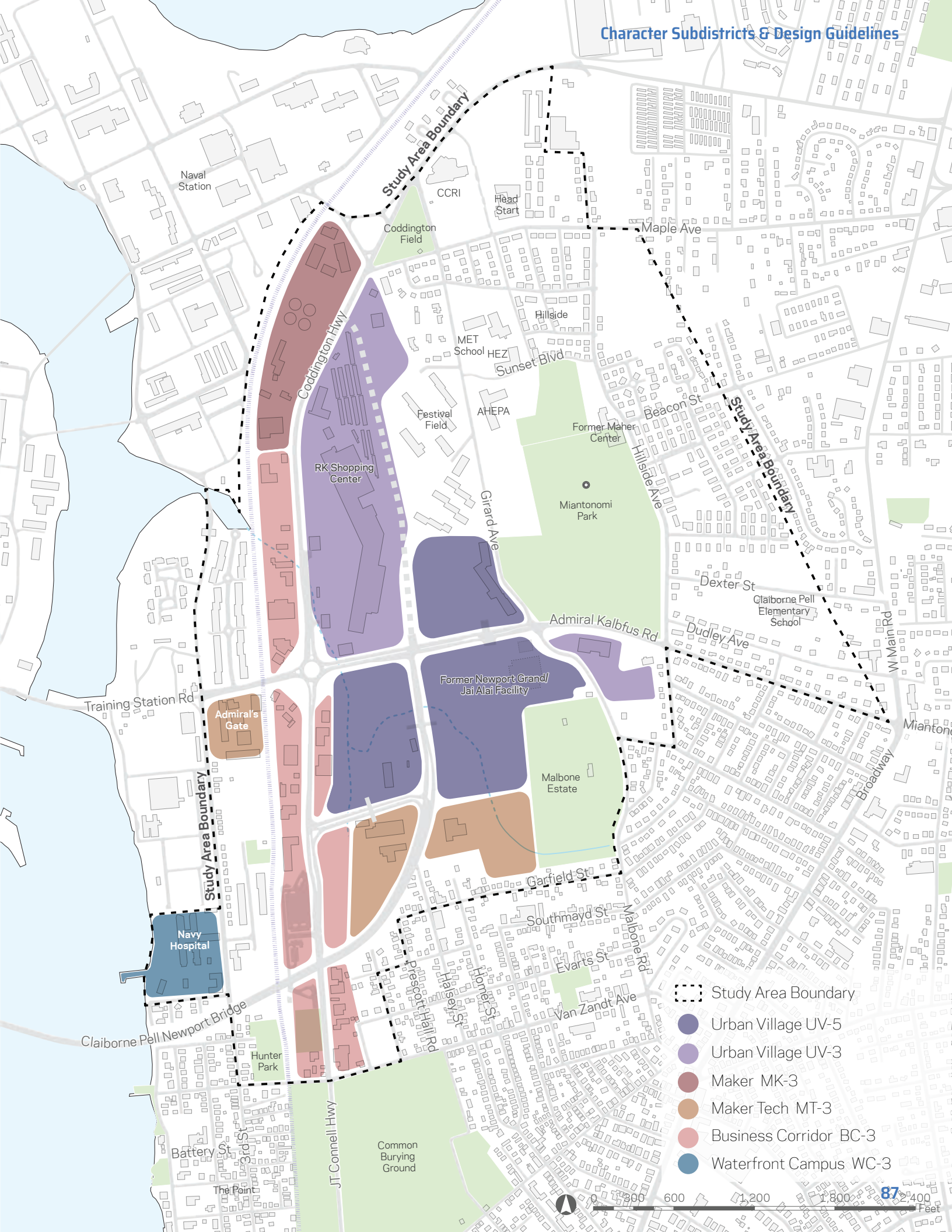

# Character Districts in the North End

The *NEUP* study area is a nuanced area; there are a range of existing typologies, land uses, and built environment. Within the study area is a smaller area, designated in the *Comprehensive Plan* as the Mixed Use, Innovation future land use and recast in this document as the Innovation District. Much of the future development and redevelopment in the North End is likely to occur within this district, which currently consists of a range of uses and physical environments, from big box retail, to residential, to light industrial, and vacant or disused land. The successful redevelopment of this area into the “Innovation Hub” is a core component of the *Comprehensive Plan* and therefore the *NEUP*. The Plan proposes a set of character subdistricts within the Innovation District with specific design guidance based on existing conditions, dominant uses, desired future uses and adjacencies, and opportunities for redevelopment.

The six character subdistricts reflect the community’s preferences for a mix of new uses that are compatible with and supportive of existing business operations. There are often overlaps in proposed uses, dimensional limitations, and priorities, but each subdistrict is unique in its character and purpose.

The following descriptions of the subdistricts are intended to provide a vision for each. Detailed guidance for each subdistrict and for street networks can be found in *Appendix A*, the proposed zoning code, which is incorporated into the *NEUP* as guidance for development within the Innovation District and should serve as design guidelines until such a time as it is incorporated into the City zoning ordinance.



-  Study Area Boundary
-  Urban Village UV-5
-  Urban Village UV-3
-  Maker MK-3
-  Maker Tech MT-3
-  Business Corridor BC-3
-  Waterfront Campus WC-3

## Village Core Mixed Use District with 5 story maximum

The Urban Village will be a dense, mixed-use development area at the terminus of the Newport Pell Bridge, serving as a “gateway” to Newport for those arriving via the Bridge. Because it will be a gateway and a crossroads, the intensity and quality of development in the Urban Village should both be high. Open spaces, signage and wayfinding, streetscape, and architecture should communicate the best that Newport has to offer. This area should serve as a landing for visitors and as a neighborhood hub for North End residents.

The large parcels of the former jai alai facility, relocated City Yard and waste transfer facilities, and land that will be available after the reconstruction of the Bridge approaches present an opportunity for the Urban Village’s transformation into a walkable, mixed-use neighborhood. While jobs-focused uses should be prioritized, a mix of activities accessible by foot or bicycle must complement those commercial uses to create a complete neighborhood.

Future development should be approved with appropriate scale of new blocks that are more in keeping with the traditional block sizes in Newport, as described in *Appendix A*. All new roadways should support generous walking and landscape areas to ensure ample tree cover.

This area presents an excellent opportunity for daylighting Elizabeth Brook, as discussed in the *Resiliency Theme*. A signature open space serving as a gathering point for residents is a clear need for for this subdistrict as well. A

bowtie design that spans Halsey Street, as shown in the illustrated studies in Appendix B, is an example of the kind of unique space that is also reflective of Newport’s existing character. The signature open space should be more focused on programming and events than nearby open spaces such as Miantonomi



Park, given its central location within newly developable areas.

Special considerations include allowing buildings up to 5 stories in height to mark this subdistrict as a focal point for the North End.

The Village Core areas have small scale green and open spaces that relate to some of Newport's most iconic public spaces, such as Washington Square.

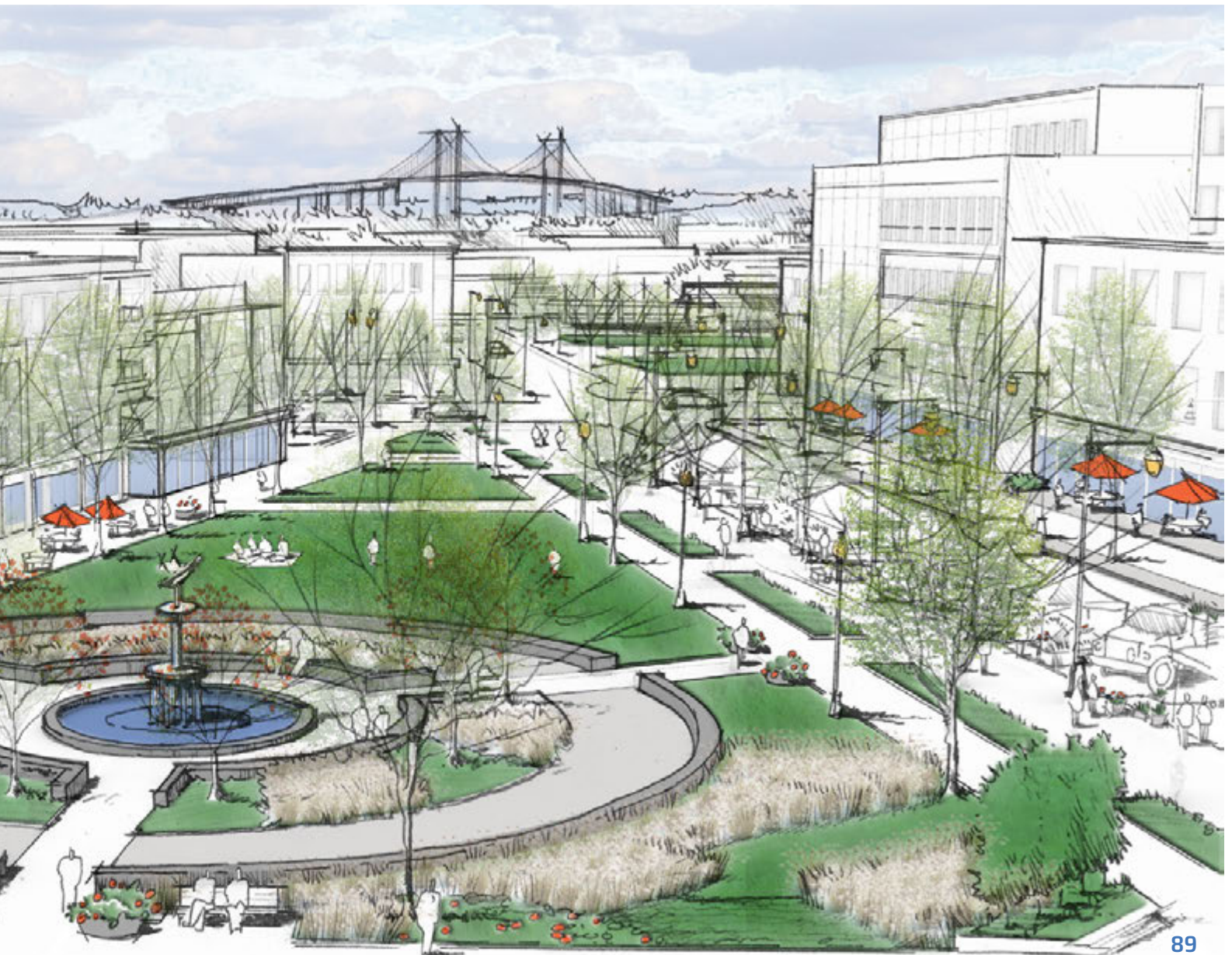

## Village Core Mixed Use District with 3 story maximum

This character subdistrict primarily covers the area of the existing RK Towne Center shopping center and the adjacent properties to the north along the eastern side of JT Connell Highway, which is currently all commercial, retail and industrial in use. The *NEUP* proposes that this subdistrict become a mixed-use area with retail, office, and housing uses in a more walkable and dense development pattern.

The redevelopment of the RK shopping center and surrounding parcels will need to include more pedestrian connectivity from North End neighborhoods to retail services at the shopping center on JT Connell Highway. Access today is problematic for pedestrians, as there are few roadways or accessible paths connecting Girard Avenue to JT Connell Highway and those roadways tend to have poor pedestrian accommodations. As outlined in the *Connectivity Theme*, extension of Halsey Street through the site is a priority and would serve the community in a number of critical ways. This extension would likely need a right-of-way easement or limited acquisition from the RK shopping center.

As suggested by this subdistrict's name, its purpose is similar to that of the Urban Village Mixed Use with 5 story maximum, but it should serve as a transition zone between the denser subdistrict and surrounding uses.



As already seen in Broadway, a relative variety in building heights can help to enhance the character of the Village Core, while responding at the different uses of the future buildings.



Wide sidewalks, street furniture, planting, and onstreet parking along the street can provide both the traffic flow and walkability that help street retail thrive.



As shown here along western Memorial-Lower Thames, variety in materials, textures and styles presents opportunities to enhance the character of the Village Core frontages. The relationship between this three factors should be studied to ensure variety and cohesiveness.



Although underutilized as a parking lot, the framed setback at Newport Family and Cosmetic Dentistry on Broadway creates diversity in the size and scale of the retail frontage influences the walkability and perception of urban grain.



Potential view of Miantomi Tower through a redeveloped RK Town Center from JT Connell Highway. Planted and generous sidewalks bordered by active ground floor uses define the Village Core experience. In these areas, the streets connect green open spaces, with diverse neighborhood scale parks and plazas located along the North End.

## Business Corridor

Many of Newport's larger commercial uses currently exist along JT Connell Highway, and with few viable locations left in the city for such uses, this is where they should remain, provided their use and dimensions consistent with the goals of the Innovation District. However, there is much room for improvement in their environment that could help such businesses grow, enhance access for residents, and improve the character of the area. A mixed-use element should accompany commercial uses to support vibrancy in the area. Allowing residential uses as an ancillary use to businesses will help further reconnect the North End to the rest of the city along its main corridor towards downtown via Farewell St.

The vision for the Business Corridor character subdistrict is to beautify and enhance the pedestrian amenities and safety along the JT Connell corridor, while supporting the existing compatible commercial businesses and encouraging other job-creating uses.

New development or redevelopment projects should reduce both the size and number of curb cuts along JT Connell Highway to improve roadway and pedestrian safety. Additional signalized crossings, narrower lanes, and other traffic calming measures must also be implemented to improve pedestrian safety and reduce vehicle speeds through the corridor.

Density in this subdistrict should increase to envelope JT Connell Highway, with buildings ranging from 2 to 3 stories adjacent to the right-of-way, rather than the single-story structures with large setbacks prevalent now.



New office and technology buildings can create a more continuous street edge, as this example in Providence, RI shows.



Traditional strip retail is not a desired use pattern for the Business Corridor, because of the hazards and discomfort it causes for those not in cars. These areas can be reconfigured to better accommodate pedestrians and cyclists, as shown in this proposed corridor transformation in Portsmouth, NH.





The transformation of auto-dominated corridors to multimodal commercial districts is possible with emphasis on increased density and encouraging diversity of uses, as in this illustration of a proposed conversion in Portsmouth, NH.



Rendering of a future possible Halsey Street. The Pell Bridge offramp is converted into a green and complete street that serves as a gateway to Newport.

## Maker

The vision for Maker subdistrict areas is the protection of the existing city sewage treatment plant from incompatible adjacent uses, while limiting heavy industrial uses from further impacting nearby residential areas. This character subdistrict encourages industrial, warehouse/maker, and light manufacturing uses that are not negatively impacted by proximity to a wastewater treatment plant.

The City should strive to promote this area as a prime location for offering affordable entrepreneurial options, including warehouse/maker space for maker uses, startups and small businesses in the North End. Options for smaller warehouse/maker spaces for individual owners should be considered.

Housing should not be allowed in this area, as it is incompatible with current and anticipated future uses.

Future development should also protect and enhance the future “rail with trail” along the railway corridor.



One Stop Building Supply Center is a good example of a use in a transition area that serves the Innovation District and the surrounding area.



Natural systems can be integrated into the Maker subdistrict to improve resiliency and buffer noxious uses from more publicly-oriented commercial uses.



View of the buildings along JT Connell Highway where Maker-oriented uses should be prioritized. The City's wastewater treatment plant is an example of the kind of uses intended for this subdistrict, which are more more focused on heavier industry.



Water management area buffering the Mixed-use Village Core from the Maker area. While creating more green open space, this area can improve the resiliency of the North End area by absorbing and retaining excess water during intense rain events.

## Maker Tech

The vision for Maker Tech is the protection and expansion of existing uses, such as the Admirals Gate complex and Tradesmen’s Center. These uses provide valuable technology and craft industries that are essential to the economy of Newport and thus should have room to grow. In particular, the entrepreneurial opportunities offered at the Tradesmen’s center could be expanded at the former incinerator site and on land remaining from reconstruction of the Newport Pell Bridge approaches.

The relocation of the waste transfer facility to Gate 4 will allow the redevelopment of the old incinerator location for uses more compatible with the surrounding residential uses and in concert with the vision for the gateway outlined in the Urban Village Mixed Use Subdistrict with 5 story maximum. A conversion of part of this subdistrict to Urban Village Mixed Use Subdistrict with 3 story maximum to provide better consistency with abutting areas may be feasible, provided that environmental conditions in those areas do not preclude the types of uses allowed in the Urban Village Mixed Use Subdistrict with 3 story maximum.

Special considerations include the incorporation of wetland features on low-lying parcels to improve stormwater storage areas and enhancing physical access for the existing and intended future land uses.



Easy access to the Newport Pell Bridge has long served a critical role for businesses such as those existing and encouraged in the Maker Tech subdistrict.



Blue Economy enterprises, such as sailmaking (pictured, Jasper & Bailey Sailmakers), fisheries support, precision machining, and other trades should be the focus of land uses in the Maker Tech areas.



Aerial view of the Tradesmen's Center and Waste Transfer Station.



There is potential to expand the Tradesmen's Center as a service, manufacturing, and jobs hub for Newport.

## Waterfront Campus

The former Navy hospital site should become a combination of public open space along the waterfront, compatible Blue Economy research in the main building, and potential housing in the two structures on 3rd Street.

Public access to the waterfront is a top priority for this subdistrict; this is the only place in the North End with substantial additional public waterfront space. However, ensuring adequate dock space for research vessels and other Blue Economy enterprises is critical to Newport's economic future. These two uses are compatible and must be balanced.

Future projects and plans should consider the goals and policies of the Harbor Management Plan when waterfront parcels are being developed. Future waterfront programming may include dockage for research vessels, transient and dinghy docks, and a water taxi station. Additional docks and slips are a persistent need for Newport's recreational boating community. Other water-dependent recreational activity, such as kayaking, should also be considered for future programming. Connectivity planning across the study area should anticipate these future water-based uses as residents move across the site toward a newly accessible public waterfront.



Aerial view of the former Navy hospital site.



Early 20<sup>th</sup> century institutional brick buildings define the character of the western part of 3rd street.



Rendering of the former Navy hospital waterfront from the City of Newport archives, showing significant public waterfront access.

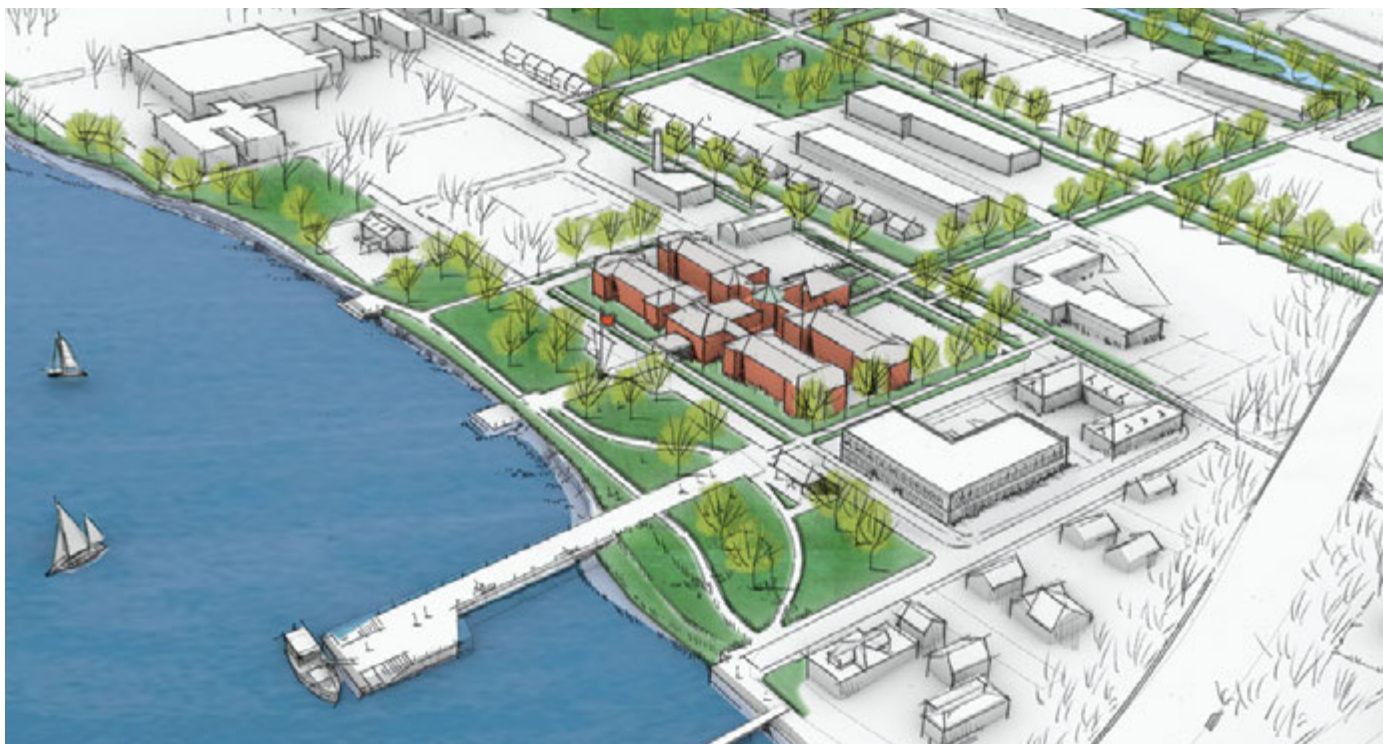

Rendering of a potential redevelopment of the former Navy hospital site. A system of tree-planted streets can improve the connectivity between the waterfront and research campus with the rest of the North End.





# 4

# IMPLEMENTATION



# DEVELOPMENT ACTIONS

For truly successful transformation of the North End to take place, a combination of development actions and infrastructure improvements must occur in a coordinated fashion. While ideally these two types of investment would happen nearly simultaneously, there will likely be a leapfrog format, with some private development following public capital expenditure, which then reinforces the need for more infrastructure, again inspiring additional private development. The *NEUP* serves as a guide to the kinds of private and public investment that should be prioritized in order to realize the vision for the North End as quickly, efficiently, and equitably as possible.

## Prioritize impacted neighborhoods

As the City works to enhance the North End through job creation, housing, connectivity, and resiliency, the diverse and inclusive community and culture established in the North End should be valued and protected. The City should proactively work on creative policies and solutions to mitigate likely displacement pressures as a result of future economic development.

## Embrace Newport's existing context – history, geography, climate, economy, and architecture – as a source of inspiration for contemporary design

Project proponents and City and State officials should carefully review the *Quality* Theme of the *Plan* for guidance on the desired character of

new development. For even greater detail, the proposed form-based code in *Appendix A* should be used as a guide to regulate development in the Innovation District until its adoption as zoning.

## Prioritize job creation

It is critical to create and adhere to zoning that supports the creation of year-round, diverse employment, as described by the *Opportunity* Theme, without sacrificing the values embodied by other Themes of the *NEUP*. Newport is very dependent on seasonal tourism, and has many low-wage, seasonal jobs. Proposed uses within the Innovation District should be focused on jobs, particularly those that are accessible – requiring limited higher education or providing paid training – and well-paying. Jobs in the Blue Economy, in particular, are well-suited to the North End, given Newport's unique position in that sector and the Innovation's District's proximity to the Naval Station, Narragansett Bay, and educational institutions. Conflicts between *Opportunity* and the other Themes must be weighed by the permitting authorities.

## Provide ancillary uses that support local employment and create opportunities for shared resourcing

Though jobs are the priority, zoning and subsequent development must recognize that other uses can support employment, though they may not themselves provide the kinds of jobs to be prioritized. For example, retail, open space, and residential uses provide the amenities and

housing that job seekers want to both live and work within the city. Neighborhood retail such as restaurants, cafés, hardware stores, and dry cleaners can make working in the area more convenient and more desirable. Ancillary uses that do not support the Themes of this plan should not be permitted.

All mixed-use projects should also utilize a shared parking strategy that limits the amount of reserved parking for any one use. Converting minimum parking requirements into maximum parking requirements can further emphasize the importance of other modes and limit the negative impacts of overprovision of parking. Structured parking could be used as a relief mechanism for reserved parking that exceeds maximum parking rates. Where new parking is constructed, structured parking should be incentivized as a land preservation option and encourage multiple projects access to one project's structured parking. Major projects should consider structured parking as their primary source of available parking.

### **Implement sustainable and people-oriented development practices**

All development should demonstrate best practices to the maximum extent practicable for sustainability and stormwater treatment to reduce the impact on the public stormwater drainage system and reduce the likelihood of flooding. Quality landscaping that frames architecture, provides respite for people and animals alike, and mitigates the impact of development is a priority, including the potential daylighting of Elizabeth Brook. Vegetated land



cover should be maximized and designed to mitigate urban heat island impacts, and light-colored, permeable surfaces should be used when hardscape is necessary.

New roadways within larger development parcels should be low-speed, green streets that support travel by multiple modes. All streets should incorporate green stormwater infrastructure, street trees and decorative plantings, pedestrian, and bicycle accommodations, and prioritize active ground-level street frontages. New streets must connect to the edges of parcels so that their benefits extend to adjacent parcels and created a complete network within the North End. Another key approach is the creation of slow or car-free streets or alleyways to support the pedestrian network.

In support of the City of Newport's goals for reducing greenhouse gas (GHG) emissions, projects should analyze passive and active strategies that minimize GHG emissions and maximize the use of clean and renewable energy. Project filings are to be submitted with the first formal submission or any major project change. Documentation and other elements of project filings should include:

- Preliminary Energy Model: The model should reflect building uses, location, orientation, massing, and principal envelope systems and include the proposed or target total annual GHG emissions with a breakout of primary uses, peak energy loads, energy use intensity, energy sources, and costs. Transportation by residents/employees/customers should be considered as part of the model.
- Clean and Renewable Energy: Onsite clean and renewable energy are proven means of reducing GHG emissions and are encouraged to be included to the greatest extent possible. A financial feasibility analysis should be conducted,

including consideration for onsite combined heat and power (CHP), solar photovoltaic (PV), wind and thermal systems, and, where existing service is available, distributed thermal energy or new distributed (electrical and thermal) energy (DG) and micro-grid systems. The analysis should indicate location, configuration, output, GHG reduction benefits, costs, and simple payback calculations for each potential system and, where appropriate (e.g. solar PV systems), an installer estimate or fee proposal.

- Energy Efficiency Assistance: Identify and describe engagements with utility, State, and Federal energy programs, efficiency and clean/renewable energy services, grants, rebates, and credits available to the project. Summarize the programs and their potential utilization.
- Energy Storage: Include sustainable energy storage capabilities within in large projects. This will allow Newport to improve its resiliency for an energy loss event or emergency, be prepared for the future of a cleaner grid, and allow stored energy to be released as needed, providing a continuous flow of clean energy during periods of high demand.

Greenhouse gas reduction and avoidance are priorities for the city, so tactics that reduce the need for off-site energy will be critical. All development within the study area should strongly consider adhering to at least one relevant, established building rating system. For example, new development plans in the North End could be certifiable as LEED-ND and buildings as LEED Gold.

The City should consider incorporating energy standards into the Technical Review Committee review process for projects in the North End. To avoid penalizing projects that attempt to implement renewable energy sources, setback and height relief should be considered for

renewable energy infrastructure. The use of building parapets and light poles for vertical access and small-scale wind turbines can also help incorporate renewable energy generation in less obtrusive ways.

## Provide community benefits that improve experience for the broader community

Public benefits are of critical interest and need in the North End. The *Equity* Theme of this document addresses some of the potential benefits that can be offered to the community by private developers. There are several techniques that can be used to achieve the benefits described in the *NEUP*:

- The site plan review process
- A discretionary approvals process, such as a special permit
- Grant agreements
- Developer agreements for publicly-owned parcels

Equity has been of great importance in the creation of this *Plan*. Reconnecting the North End not only physically, but also economically and socially, is a foundational goal of the *Plan*. The North End residential community included within the study area may be disproportionately impacted from new development in the nearby Innovation Hub. While fostering Opportunity, Connectivity, Resiliency, and Quality are also benefits to the community, a more defined process and public benefits strategy is necessary in order to mitigate potential negative impacts to the North End residential neighborhood.

A Community Benefits Agreement (CBA) is a contract signed by a community group and a real estate developer that requires the developer to provide specific amenities and/or mitigations to the local community or neighborhood. A CBA can

be a private agreement between a community organization and developer, or a public agreement between the City and developer and be required as a condition of approval of a project. A private CBA can consider creative solutions because it is free from certain critical legal constraints that apply to government conditions on development projects. It also requires strong community consensus and leadership to negotiate over a wide variety of deal points.

A public CBA is typically more constrained, but can incorporate community participation to identify impacts and needs, and be included as a condition of a project approval. In the absence of a private CBA, the zoning code for the North End should require a public CBA supporting residents in the study area. The *2017 Comprehensive Plan* calls for the creation of a Floating Zone in the Innovation Hub, an ideal mechanism for incorporating a provision for a public CBA. The requirement for some public benefits should also extend to projects choosing not to utilize the floating zone. The Land Development Project approval process or required conditions of approval for Development Plan Review, may act as a conduit for public benefits and may be further utilized in the underlying zoning to offset negative development impacts.

To advise the City Council, Planning Board, Technical Review Committee, and Planning Department on the benefits most apt to benefit the community, the City Council should establish a North End Benefits Committee that includes representation from the North End and the city's populations that experience significant disparities. Care should be given to prevent any conflicts of interest between members of this committee and other groups negotiating a non-City CBA with the same real estate developer for the same project.

# Infrastructure Actions

## Coordinate with RIDOT to create better connections and optimize development opportunities

The City must continue to coordinate with RIDOT on the Newport Pell Bridge approaches and future RIDOT projects in the study area to ensure that all street improvements serve the network described in the *Connectivity Theme* of the *Plan*. These streets must be built to desired standards that sufficiently manage stormwater, provide tree canopy and decorative plantings, and safely and comfortably accommodate pedestrians, cyclists, and transit users.

Furthermore, the owners of RK Towne Center shopping center, the City, and RIDOT must work together to ensure the extension of Halsey Street from Admiral Kalbfus Road to Coddington Highway is achieved.

The construction or reconstruction of wetlands within the Newport Bell Bridge approaches project area is a critical action that will heavily influence development opportunity and the resultant character of the Innovation District. This must serve the open space network and development pattern described in the *Resiliency Theme* of this Plan. Stormwater storage and conveyance parallel to JT Connell Highway should enhance both experience and performance and complement opportunities for redevelopment.

The rebuilding of the Bridge approaches presents an opportunity for dramatic, positive change to the landscape. The fill currently used for the approaches will be excess material during and after reconstruction, and that soil and

aggregate could be used to regrade development sites within the flood plain to reduce flood risk.

## Enhance the city's existing transportation network

The existing rights-of-way between JT Connell Highway and 3rd Street should be preserved and improved in conjunction with the "rail-and-trail" concept to provide additional pedestrian connections between those two heavily-used streets once the reconstruction of the Pell Bridge approaches is complete. Further enhancements with mid-block multi-use paths should be created as shown in the *Connectivity Theme*.

A more specific location for a multimodal center in the North End should be selected that serves new development and connections to other parts of the city. This facility should be combined with dense mixed-use development to fully utilize the parking and transit resources on a continuous basis. A park-and-ride element should be considered when planning the multimodal center. It is important to limit cars entering downtown and promote alternative ways to enter the city and enjoy Newport. While multiple locations are possible, the multimodal center should be constructed with consideration for adjacent uses, desired traffic patterns, and funding sources.

## Coordinate with governmental agencies and area institutions to better prepare for climate change

Achieving protection from long-range sea-level rise will require coordination with Naval Station

Newport. An evaluation of the possibility for a tide gate or storm surge gate at the outlet of Elizabeth Brook should be prioritized to understand the benefits of such infrastructure.

The Newport Housing Authority may be a partner for the provision of interim food production on vacant public parcels that are awaiting permanent uses, which would improve resiliency for the community.

The identification and facilitation of temporary and/or permanent renewable energy facilities within the North End will help provide clean energy to end users or net metered to other sites. Expedited permitting for such facilities that meet specified requirements could encourage their installation. Energy storage opportunities within the North End and other areas should be explored to allow for the storage of renewables and reduce peak demand for individual sites, and thus enhance the City's ability to withstand future climate change-related weather events.

### **Use public buildings and other facilities to set a high standard for design and performance**

All public facilities within the North End should be certifiable to a high-rating LEED standard, to act as a model for the Innovation District. Setting high performance standards for new development will clarify how seriously the City considers the threat of climate change and the importance of quality design.







# APPENDICES





# MODEL CHARACTER-BASED CODE AS DESIGN GUIDELINES

The *North End Urban Plan* proposes a set of character subdistricts within the Innovation District, with specific guidance based on the existing conditions, dominant uses, desires adjacencies and opportunity for redevelopment. Each subdistrict is unique in its character and purpose.

This *Plan* includes Appendix A, Character-Based Code, a form-based code for the North End Innovation District developed by the consultant team. The Character-Based Code does not replace the base and floating zone supported by the *2017 Comprehensive Plan*. Along with the Quality Theme of the *NEUP*, sections of the Character-Based Code will serve as design guidelines to provide clear guidance for development within the Innovation District.

In the event that the design guidelines conflict with the standards set out in the area zoning, the area zoning controls.



# CHARACTER BASED-CODE

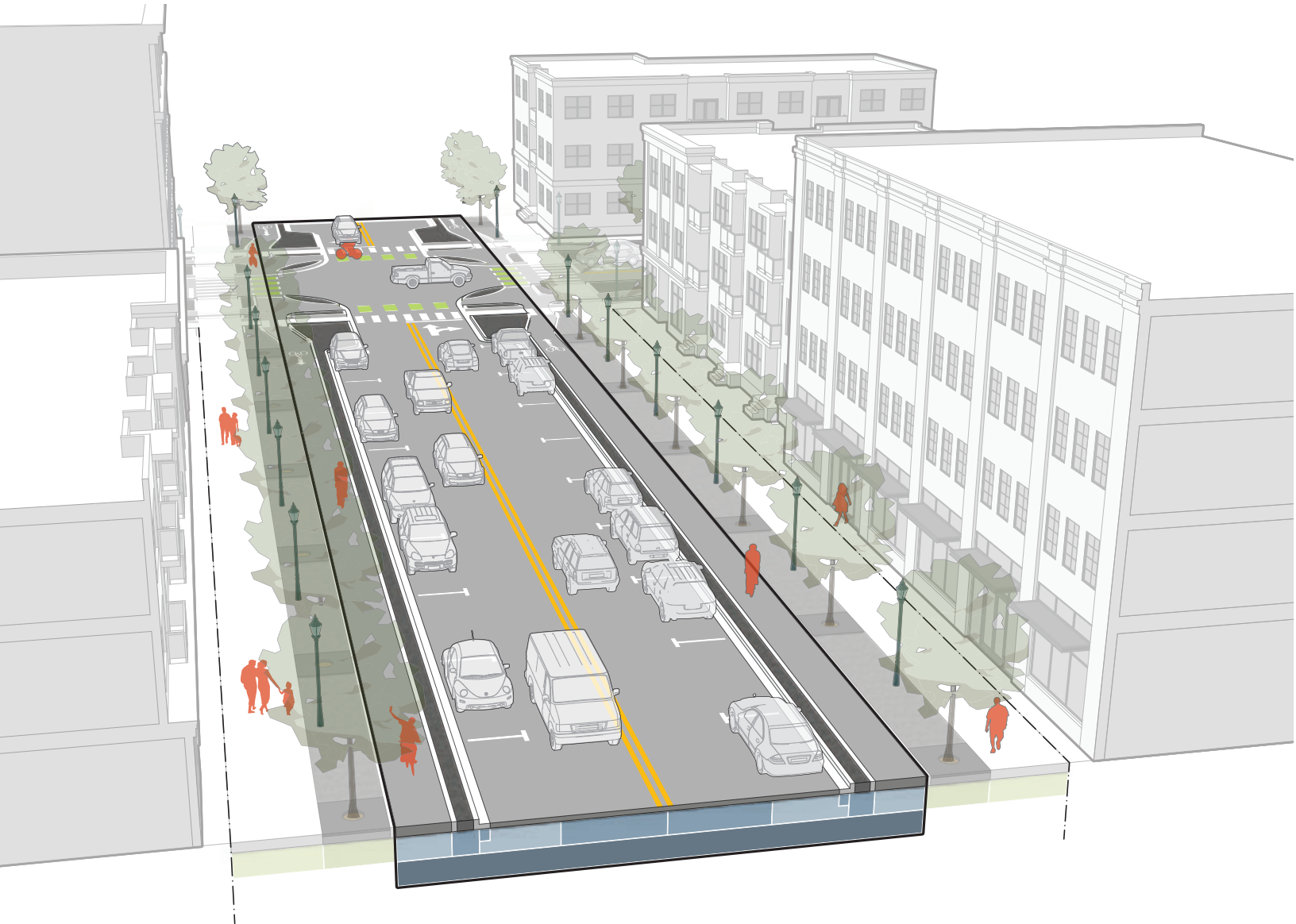

## DESIGN GUIDELINES

The following sections of the Character Based-Code are to serve as Design Guidelines.

# CONTENTS

**DISTRICTS..... Pages 5 to 31**

**H. Recommended Uses for Character Areas..... Pages 32 to 35**

This section contains recommendations for allowed (P) or specially permitted (S) uses within the Plan subdistricts and are included for guidance only. The recommendations are based on the existing conditions, dominant uses, desired adjacencies and opportunity for redevelopment within each

**FRONTAGE OVERLAYS..... Pages 36 to 71**

**PARKING AND LOADING..... Pages 72 to 77**

**LANDSCAPE AND SCREENING..... Pages 78 to 89**

**DEFINITIONS..... Pages 94 to 95**

# 17.65.10. INTRODUCTORY PROVISIONS

## A. Title

This document is the “North End Character-Based Code,” and is referred to or cited throughout this document as this “Code.”

## B. Effective Date

This Code was adopted on [insert date] and became effective on [insert date].

## C. Applicability

The North End Character-Based Code applies to all property as shown in *17.65.20, Districts* and *17.65.30, Frontages*.

## D. Legislative Intent

1. The intent of the North End Character-Based Code is to support new employment opportunities in diverse fields of high technologies; including, but not limited to: healthcare; advanced manufacturing; defense (underwater, maritime and cyber security); metadata acquisition, analytics and related computation technologies; ocean technologies and blue economy ventures; resilience/climate change research and development; alternative energy research and development; and digital industries. This is to be allowed in an appropriate mix with supportive housing, retail, recreation, cultural and open space.
2. The intent is to create a cohesive village center reflective of Newport’s impressive history, while proposing new building types, street layouts, urban and recreational spaces, and architecture to reflect modern times and needs, including resiliency in a low-lying coastal area.
3. The North End Character-Based Code is meant to work in concert with the City’s master plans for areas of the City and provide for mixed-use based economic development, foster 21st century jobs and lifestyle choices, offer clear public benefits including open spaces, the realization of health benefits associated with more walkable and bikeable streets and paths, and greater connectivity within and between the City’s neighborhoods and resources.
4. Specific components of this intent include:
  - a. To provide for economic development and employment opportunities in diverse fields, including those related to an innovation economy.
  - b. To support the development of these diverse fields as incubator/accelerator type businesses along with their support subsectors and to support the continued growth and success of these uses.
  - c. To provide live/work opportunities for workforce and makers.

- d. To provide, as amenities to the primary functions, a multi-modal district that allows for a mix of housing, recreation and a range of publicly-accessible, populated open spaces in the form of small pocket parks, trail corridors, and urban plazas that serve as amenities not only for the district, but also the surrounding areas.
- e. To support existing surrounding residential areas.
- f. To encourage, guide and direct development in the North End and ensure that the character presented in the City's master plans is maintained, and that mixed uses provide for the health and growth of the area.
- g. To have outstanding design associated with all forms of circulation, landscaping and architectural design of new developments or substantial redevelopments.
- h. To foster high density, mixed-use development, and to deter: "suburban-type" shopping centers; big box store developments; low-rise developments that emphasize parking; uses that are auto-orientated including drive-thru businesses, gas stations or other auto-related services; developments that are large-scale and single-use or stand-alone single-use, including single-family dwellings.
- i. To promote pedestrian activity on streets, with easy multi-modal access from surrounding neighborhoods.
- j. To promote a City that is resilient to climate change impacts and is environmentally sustainable, inclusive and accessible to all.

## E. Conflicting Provisions

1. Where *Title 17* conflicts with a standard set out in this Code, the standard in this Code controls.
2. Where a standard is required elsewhere in *Title 17* and is not stated in this Code, it applies.
3. Illustrations and graphics are included in this Code to illustrate the intent and requirements of the text. In the case of a conflict between the text of this Code and any Illustrations and graphics, the text of this Code governs.



## F. Districts and Frontages

The following Zoning Districts and Frontages are established.

ZONING DISTRICTS	FRONTAGE OVERLAYS
Urban Village-5 (UV-5)	Urban Village Streets
Urban Village-3 (UV-3)	- Active Core
Business Corridor-3 (BC-3)	- Business Core
Maker Tech-3 (MT-3)	- Residential Core
Maker-3 (MK-3)	- Secondary
Waterfront Campus-3 (WC-3)	Existing Streets
	- Arterial
	- North Arterial
	- Boulevard
	- Local



# 17.65.20. DISTRICTS

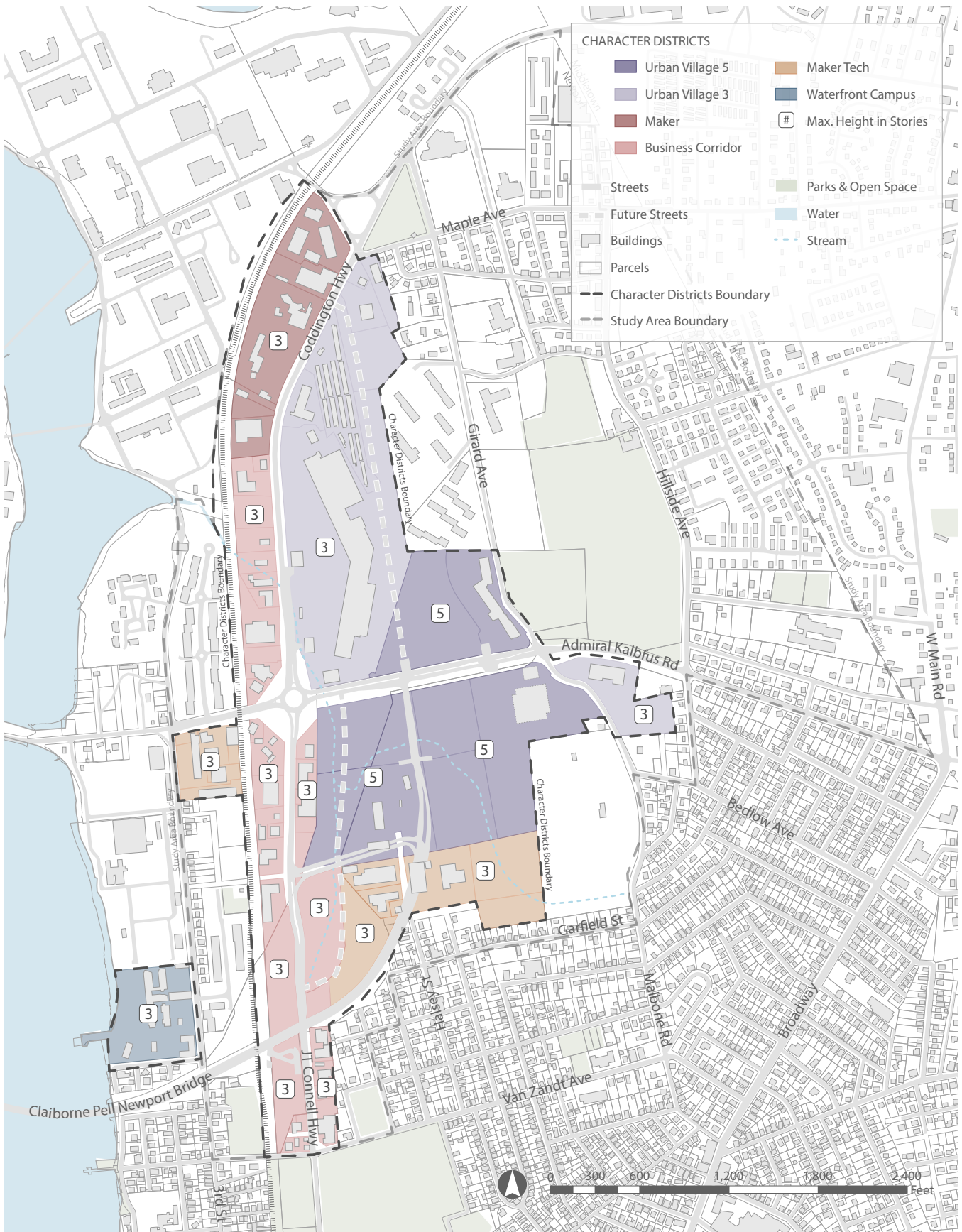

# A. Urban Village-5 [UV-5]

## District



### 1. INTENT

The Urban Village-5 district is intended to create an urban, mixed-use village with an emphasis on technology-related employment activity that connects the neighboring community to jobs, housing and urban amenities through a network of pedestrian-oriented streets. Buildings can be no taller than 5 stories in height.

### 2. BLOCKS

17.65.20.G.1

- A Perimeter (max) 1,600'
- B Length (max) 600'

### 3. STREETS

17.65.20.G.2

- C Village Core Street spacing (max) 1,000'

### 4. FRONTAGE

17.65.20.G.3

Village Core Streets

- D Active Core (min) 20%
- E Business Core, Residential Core Remainder

Village Secondary Streets

Active Core, Business Core, Residential Core, Secondary 100%

Existing streets See Frontage Map

### OPEN SPACE

17.65.20.G.3

- F Area (min) 5%

## Site

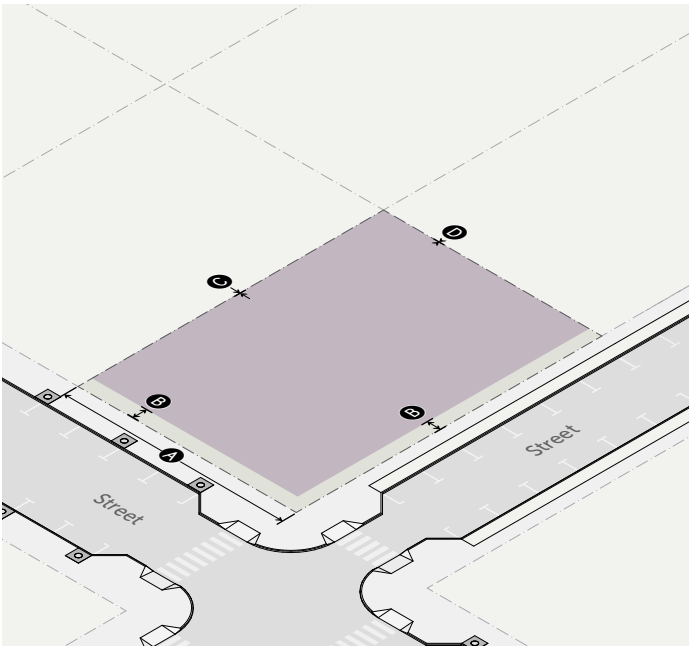

### 5. LOT 17.65.20.G.5

**A** Width (min) 15'

### 6. BUILDING SETBACKS 17.65.20.G.6

**B** Front line (min) See Frontage

**C** Side line (min) 0'

**D** Rear line (min) 0'

### 7. TRANSITIONS 17.65.20.G.7

Transition Type A1

## Massing

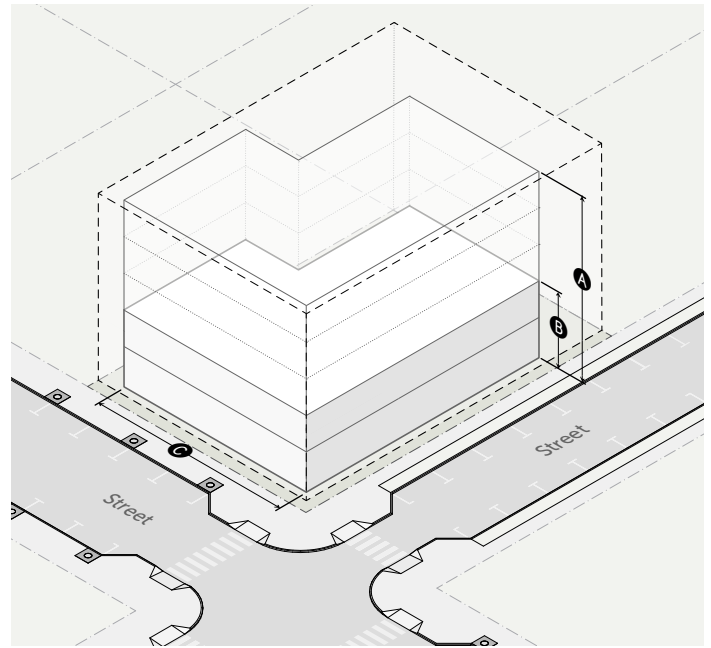

### 8. BUILDING 17.65.20.G.8

**A** Height (max) 5 stories/65'

**B** Height (min) 2 stories

**C** Width (max) 150'

## B. Urban Village-3 [UV-3]

### District



#### 1. INTENT

The Urban Village-3 district is intended to create an urban, mixed-use village with an emphasis on technology-related employment activity that connects the neighboring community to jobs, housing and urban amenities through a network of pedestrian-oriented streets. Buildings can be no taller than 3 stories in height.

#### 2. BLOCKS

17.65.20.G.1

- Ⓐ Perimeter (max) 1,600'
- Ⓑ Length (max) 600'

#### 3. STREETS

17.65.20.G.2

- Ⓒ Village Core Street spacing (max) 1,000'

#### 4. FRONTAGE

17.65.20.G.3

##### Village Core Streets

- Ⓓ Active Core (min) 20%
- Ⓔ Business Core, Residential Core Remainder

##### Village Secondary Streets

- Active Core, Business Core, Residential Core, Secondary 100%

##### Existing streets

See Frontage Map

#### OPEN SPACE

17.65.20.G.4

- Ⓕ Area (min) 5%

## Site

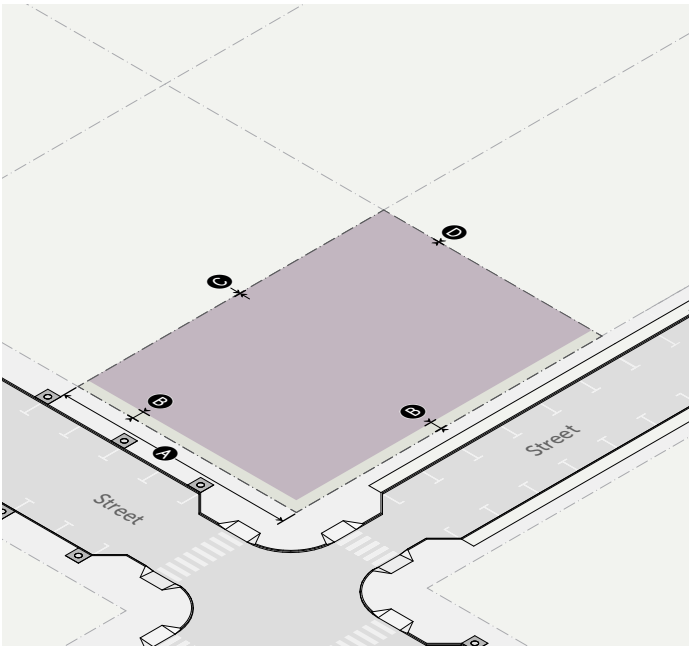

### 5. LOT 17.65.20.G.5

**A** Width (min) 15'

### 6. BUILDING SETBACKS 17.65.20.G.6

**B** Front line (min) See Frontage

**C** Side line (min) 0'

**D** Rear line (min) 0'

### 7. TRANSITIONS 17.65.20.G.7

Transition Type A2

## Massing

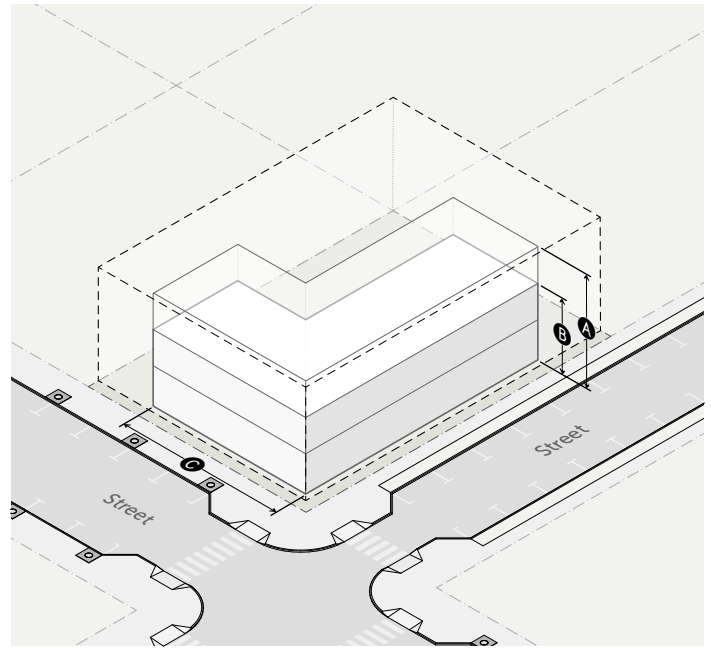

### 8. BUILDING 17.65.20.G.8

**A** Height (max) 3 stories/45'

**B** Height (min) 2 stories

**C** Width (max) 150'

# C. Business Corridor-3 [BC-3]

## District

The Business Corridor district is intended to accommodate retail and other commercial uses and support existing and new industrial businesses while improving the experience of bicyclists and pedestrians along JT Connell Highway and the future trail system.

## Site

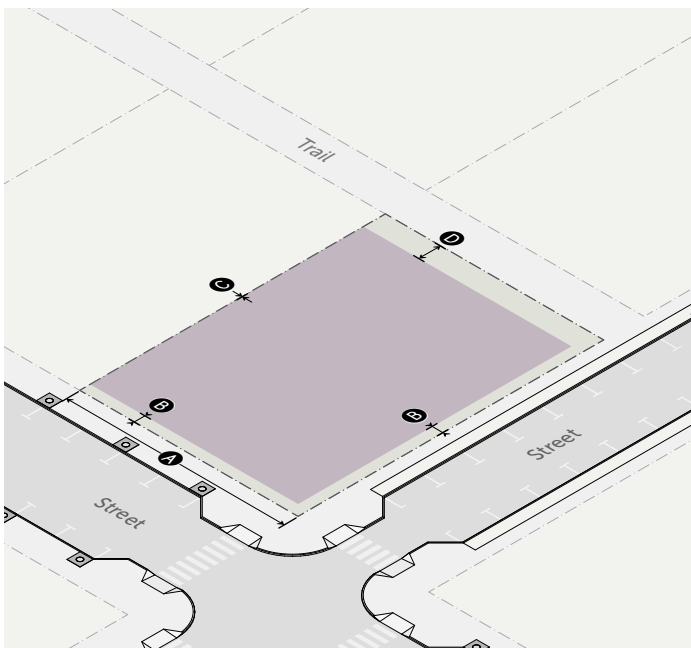

## Mass

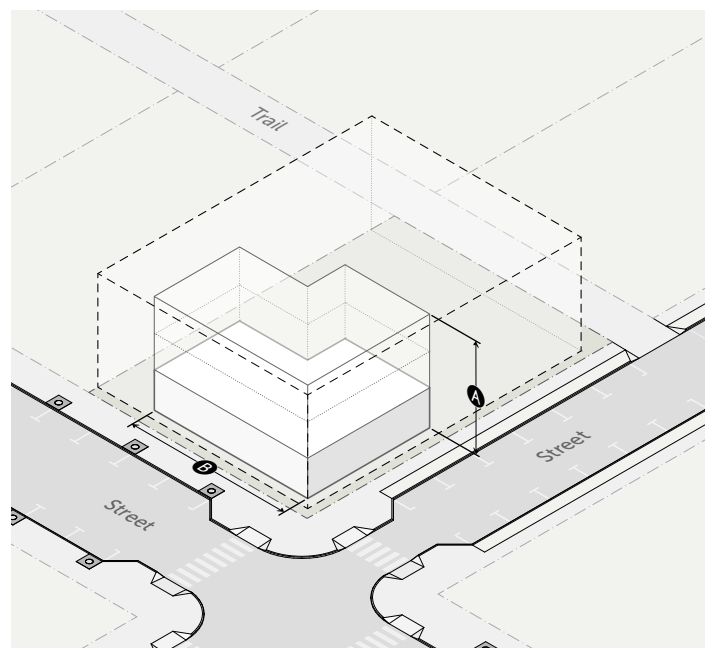

<b>1. LOT</b>	17.65.20.G.5
<b>A</b> Width (min)	100'
<b>2. BUILDING SETBACKS</b>	17.65.20.G.6
<b>B</b> Front line (min)	See Frontage
<b>C</b> Side line (min)	0'
<b>D</b> Rear line (min)	10'
<b>3. TRANSITIONS</b>	17.65.20.G.7
Transition	Type A2

<b>4. BUILDING</b>	17.65.20.G.8
<b>A</b> Height (max)	3 stories/45'
<b>B</b> Width (max)	200'



## D. Maker Tech-3 [MT-3]

### District

The Maker Tech district is intended to protect existing industrial businesses and encourage new local businesses that provide employment, with a focus on research and technology-based industries.

### Site

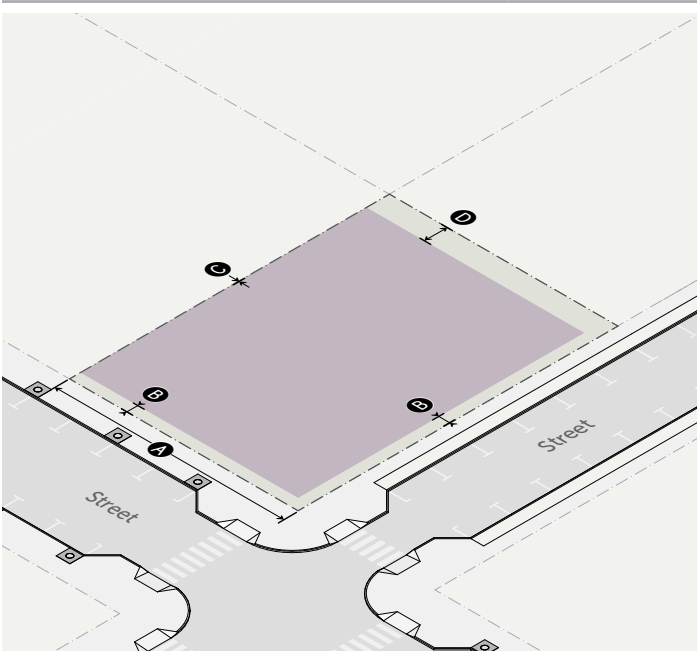

#### 1. LOT 17.65.20.G.5

**A** Width (min) 50'

#### 2. BUILDING SETBACKS 17.65.20.G.6

**B** Front line (min) See Frontage

**C** Side line (min) 0'

**D** Rear line (min) 10'

#### 3. TRANSITIONS 17.65.20.G.7

Transition Type A2

### Mass

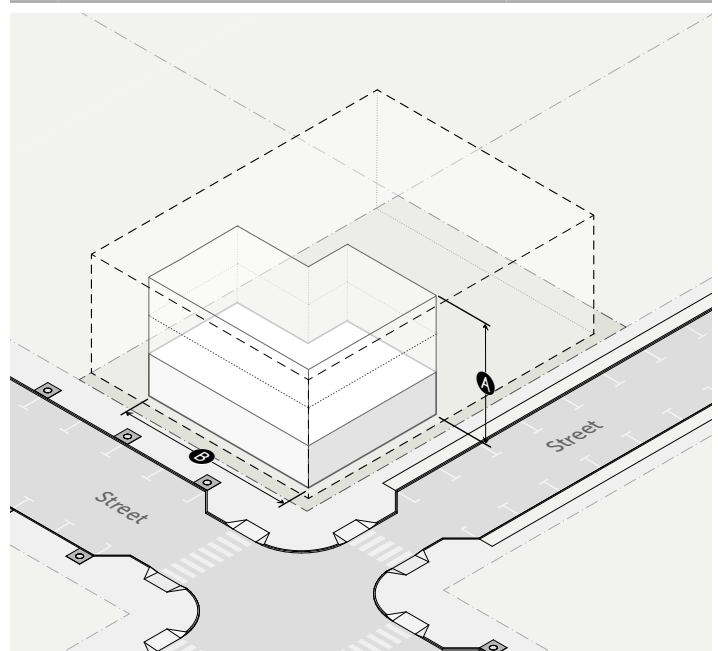

#### 4. BUILDING 17.65.20.G.8

**A** Height (max) 3 stories/45'

**B** Width (max) 300'

# E. Maker-3 [MK-3]

## District

The Maker district is intended to protect existing industrial businesses and encourage new local businesses that provide employment for the community.

### Site

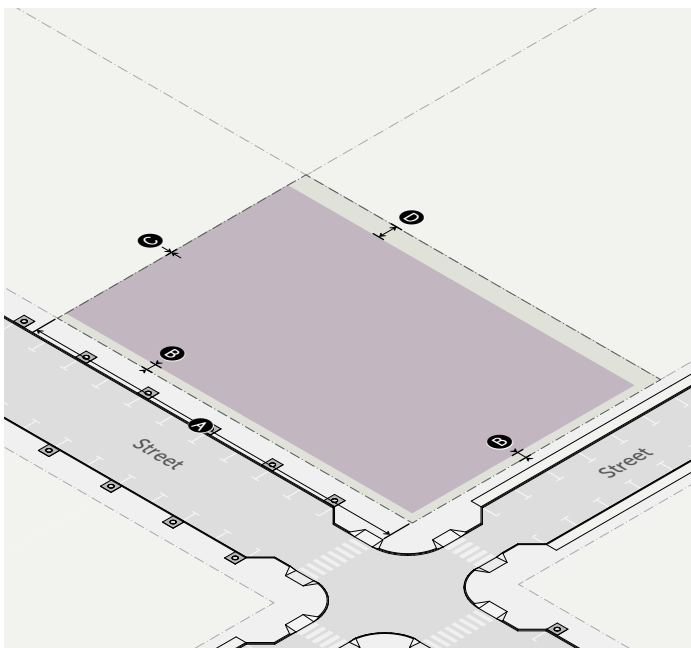

<b>1. LOT</b>	17.65.20.G.5
<b>A</b> Width (min)	200'
<b>2. BUILDING SETBACKS</b>	17.65.20.G.6
<b>B</b> Front line (min)	See Frontage
<b>C</b> Side line (min)	0'
<b>D</b> Rear line (min)	10'
<b>3. TRANSITIONS</b>	17.65.20.G.7
Transition	Type A2

### Mass

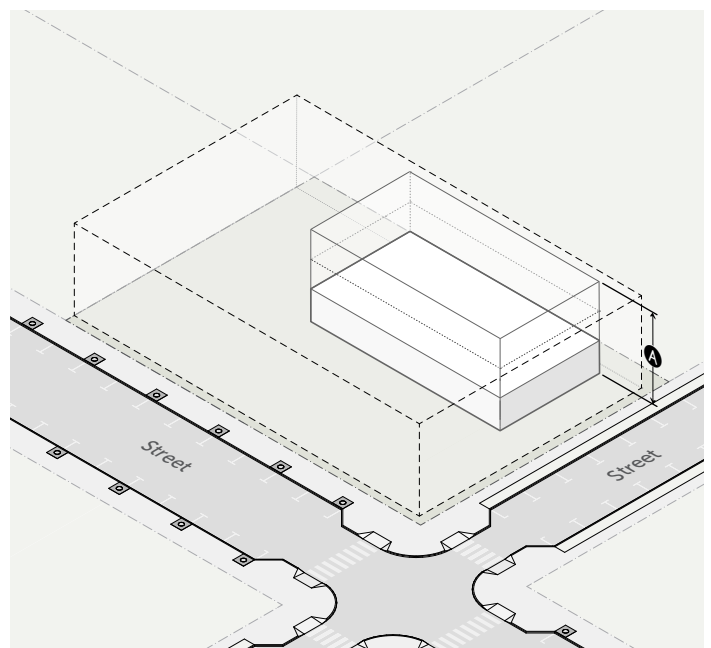

<b>4. BUILDING</b>	17.65.20.G.8
<b>A</b> Height (max)	3 stories/45'

## F. Waterfront Campus-3 [WC-3]

### District

The Waterfront Campus district is intended to accommodate research and development uses while providing public access to the waterfront and park-oriented amenities.

### Site



#### 1. LOT 17.65.20.G.5

**A** Width (min) 20'

#### 2. BUILDING SETBACKS 17.65.20.G.6

**B** Front line (min) See Frontage

**C** Side line (min) 0'

**D** Rear line (min) 10'

#### 3. TRANSITIONS 17.65.20.G.7

Transition Type A2

### Mass

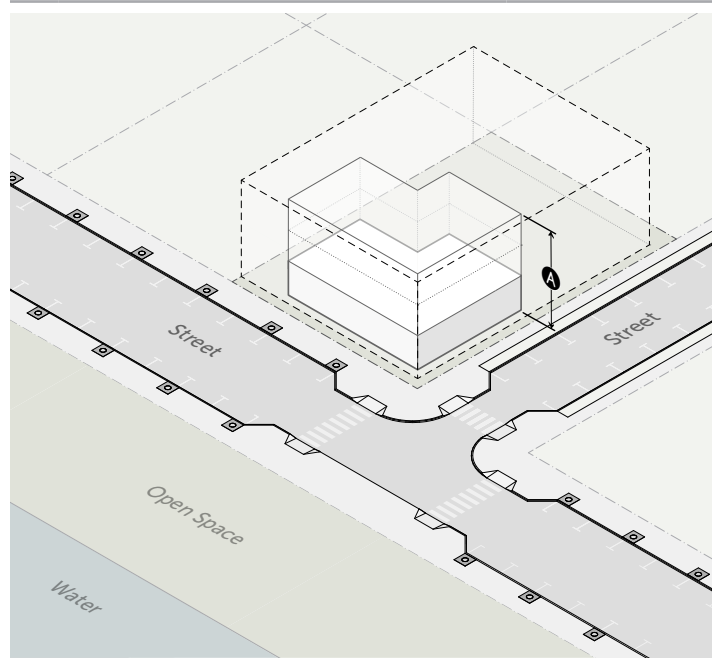

#### 4. BUILDING 17.65.20.G.8

**A** Height (max) 3 stories/45'

## G. Rules of Interpretation

### 1. Blocks

#### a. Applicability

- 1) Lots in an Urban Village District greater than 75,000 square feet are required to meet the maximum block perimeter requirement.
- 2) Lots in an Urban Village District wider than 600 feet must meet the maximum block length requirement.

#### b. Standards

- 1) For the purpose of the maximum block perimeter and block length, a block is all contiguous lots bounded by public or private streets, not including alleys or pedestrian connections.
- 2) Newly constructed streets used to meet a maximum block requirement must meet *17.65.20.G.2*.
- 3) Where a block includes an alley (that meets *17.65.20.G.2.h*) or a pedestrian connection (that meets *17.65.20.G.2.i*) that provides a through-block connection, the maximum block perimeter and block length requirement may be increased by 25%.
- 4) Where a block perimeter or block length standard cannot be met because a connection to an existing street is not allowed by RIDOT, a pedestrian connection (that meets *17.65.20.G.2.i*) between the new and existing street may be used to complete the through connection.
- 5) Where the block perimeter standard cannot be met because of steep slopes in excess of 25%, highways, waterways, railroad lines, conservation areas or major utility easements would make the provision of a conforming block infeasible, the Planning Board may waive the requirement.
- 6) Blocks abutting and within 400 feet of a steep slope in excess of 25%, highways, waterways, railroad lines, conservations area, or major utility easements, may exceed the maximum block length standard by 100%, if a through-block pedestrian connection (that meets *17.65.20.G.2.i*) is provided perpendicular to the block face exceeding the block length standard, spaced no more than the maximum block length.
- 7) Where land ownership patterns prevent a through street, a street stub must be provided to enable a future through street connection.
- 8) If a stub exists on an abutting property, the street system of any new development must connect to the stub to form a through street.

### c. Measurement

- 1) Block perimeter is measured along the lot lines abutting a street right-of-way.

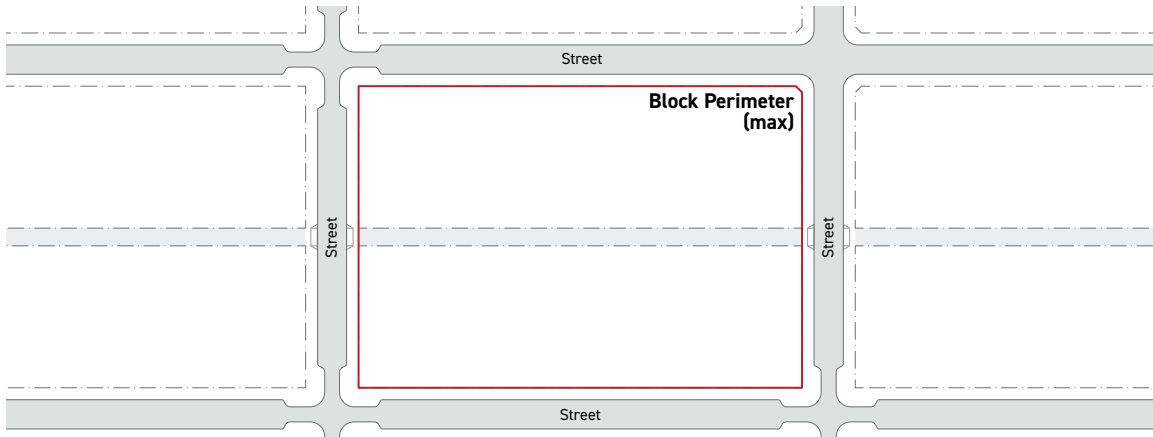

- 2) Block length is measured along the lot lines abutting a street right-of-way.

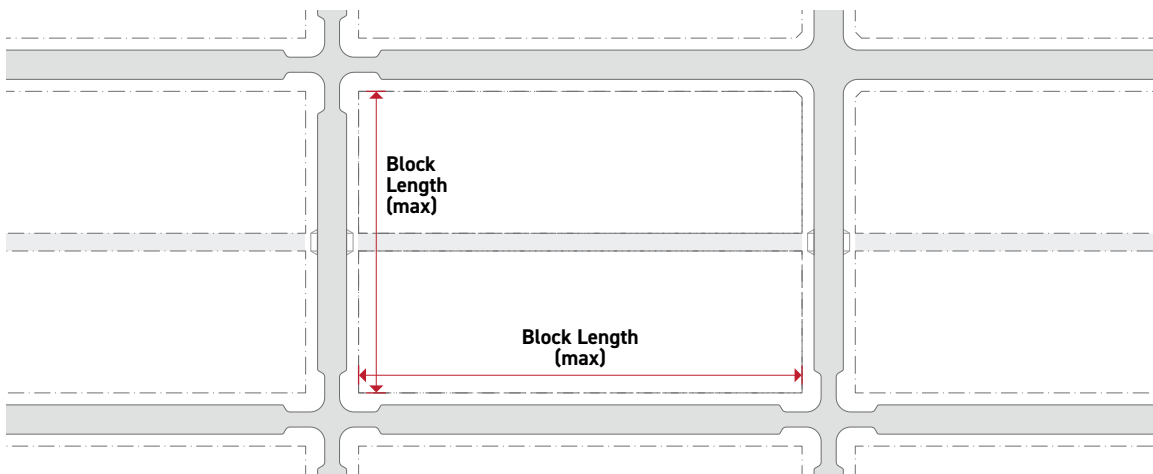

## 2. **Right-of-Way**

### **a. Applicability**

All rights-of-way created or altered in accordance with the City of Newport Subdivision Regulations.

### **b. Village Core Streets**

A network of Village Core Streets must be provided according to the following standards.

- 1) Each Village Core Street must meet *17.65.20.G.2.f*.
- 2) Village Core Streets must connect continuously through a site, connecting to abutting streets or property in a general North to South direction, as well as an East to West direction.
- 3) A Village Core Street can be located no more than 600 feet from the edge of the site.
- 4) A Village Core Street can be located no more than 1,000 feet from another Core Street.
- 5) Where an existing Village Core Street stub or intersection abuts on adjacent property, the Village Core Street network must connect to the existing Village Core Street stub.
- 6) Existing streets with a designation of Principal Arterial or Minor Arterial in the 2017 Newport Comprehensive Plan cannot be designated a Village Core Street.

### **c. Non-Core Streets**

Remaining new streets that are not required to be Village Core Streets can meet either:

- 1) *17.65.20.G.2.f, Village Core Street* or
- 2) *17.65.20.G.2.g, Village Secondary Street*.

### **d. Bicycle Streets**

A network of dedicated bicycle infrastructure must be provided according to the following standards.

- 1) Bike facilities either within street rights-of-way or in dedicated multi-use pathway public easement or right-of-way must connect continuously through the site in a general North to South direction, as well as an East to West direction.
- 2) Bicycle facilities must be located no more than 3,000 feet from other roughly parallel bicycle facilities.
- 3) Bicycle facilities provided in a Village Core Street must meet *17.65.20.G.2.f*.
- 4) Bicycle facilities provided in a Village Secondary Street must meet *17.65.20.G.2.g*.

- 5) Bicycle facilities not provided in Village Core Street or Village Secondary Street must meet the bike facility requirements of 17.65.20.G.2.i, *Pedestrian Connection* or 17.65.20.G.2.j, *Multi-Use Pathway* and be provided in a dedicated right-of-way or dedicated public easement.

### e. Measurement

- 1) Village Core Street spacing from within the development is measured from street centerline to street centerline.
- 2) Village Core Street spacing from the edge of the site is measured from the property line inwards to the Village Core Street centerline.

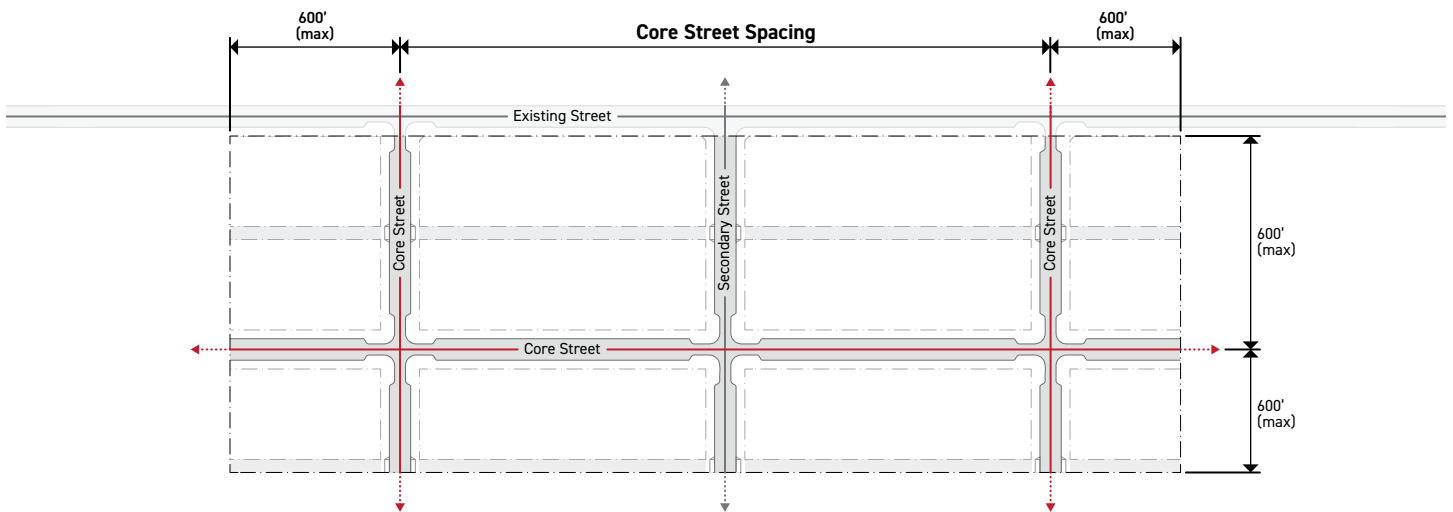

- 3) Bicycle facility spacing is measured from edge of bike facility to edge of bike facility.

## f. Village Core Street

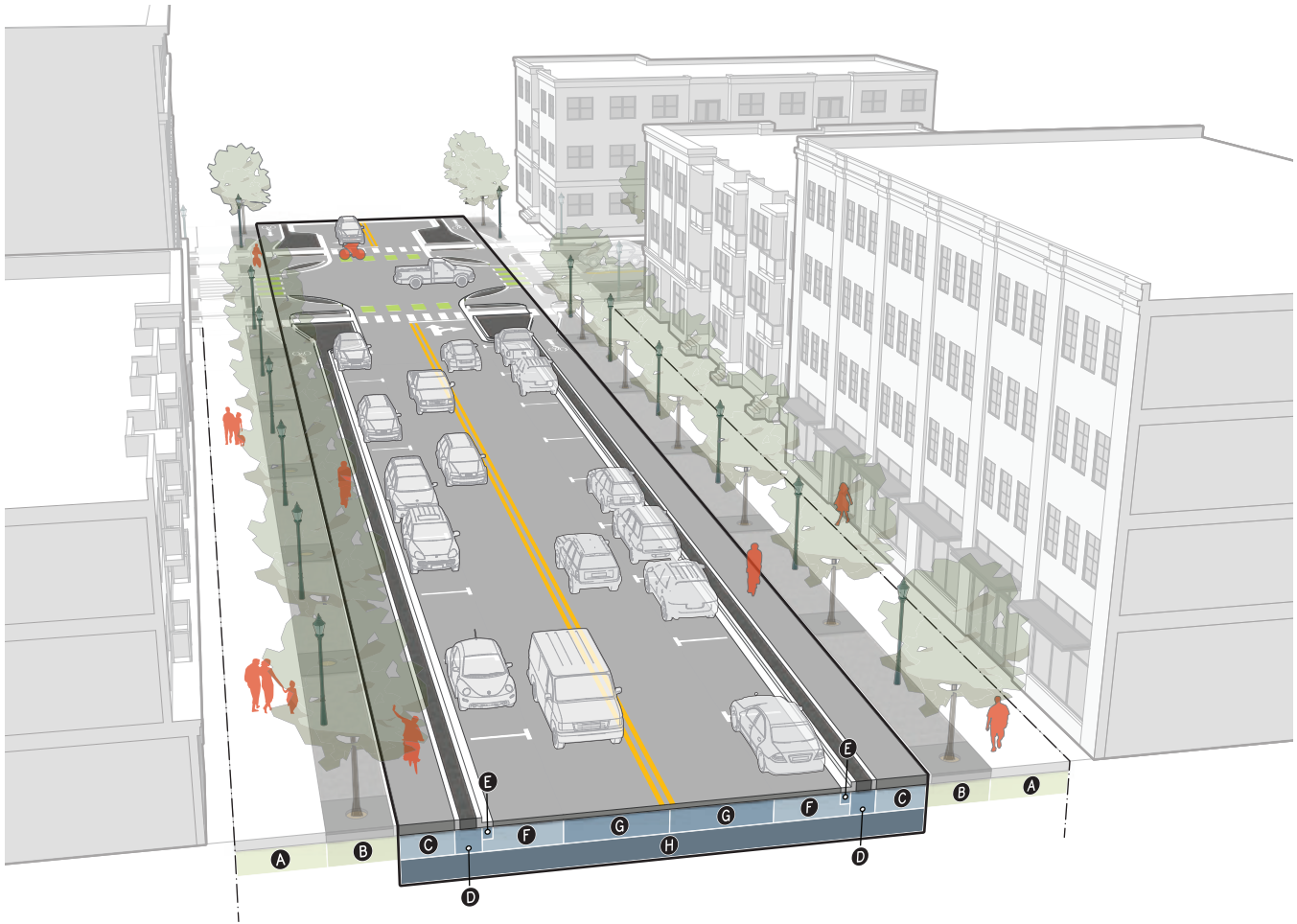

### STREETSCAPE

- |                          |              |
|--------------------------|--------------|
| <b>A</b> Pedestrian zone | See Frontage |
| <b>B</b> Furniture zone  | See Frontage |

### STREET

- |                                |           |
|--------------------------------|-----------|
| <b>C</b> Bike lane (min)       | 5'        |
| <b>D</b> Bike buffer (min)     | 2'        |
| <b>E</b> Gutter pan (min)      | 1'        |
| <b>F</b> Curb lane (min/max)   | 8'/8.5'*  |
| Parallel parking               | Required* |
| Bulb-outs                      | Required  |
| <b>G</b> Travel lane (min/max) | 9'/10'    |

\* As an alternative to providing parallel parking, a maximum of 5% of the cumulative length of a Village Core Street may include diagonal parking on one side (curb lane can be increased to 21'). Diagonal parking must be angled between 30 and 60 degrees. Portions of Village Core Streets taking advantage of this alternative must provide parallel parking on the opposite side of the street.

### CONFIGURATIONS

	<b>H</b>
No Bike Lane	34' min
With Bike Lanes	48' min

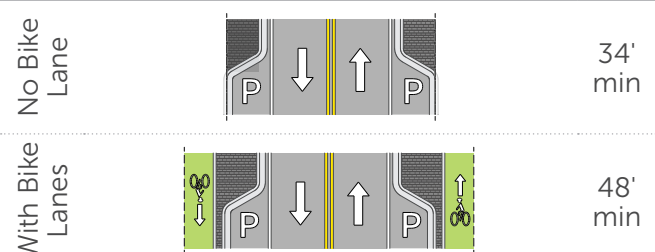



## g. Village Secondary Street

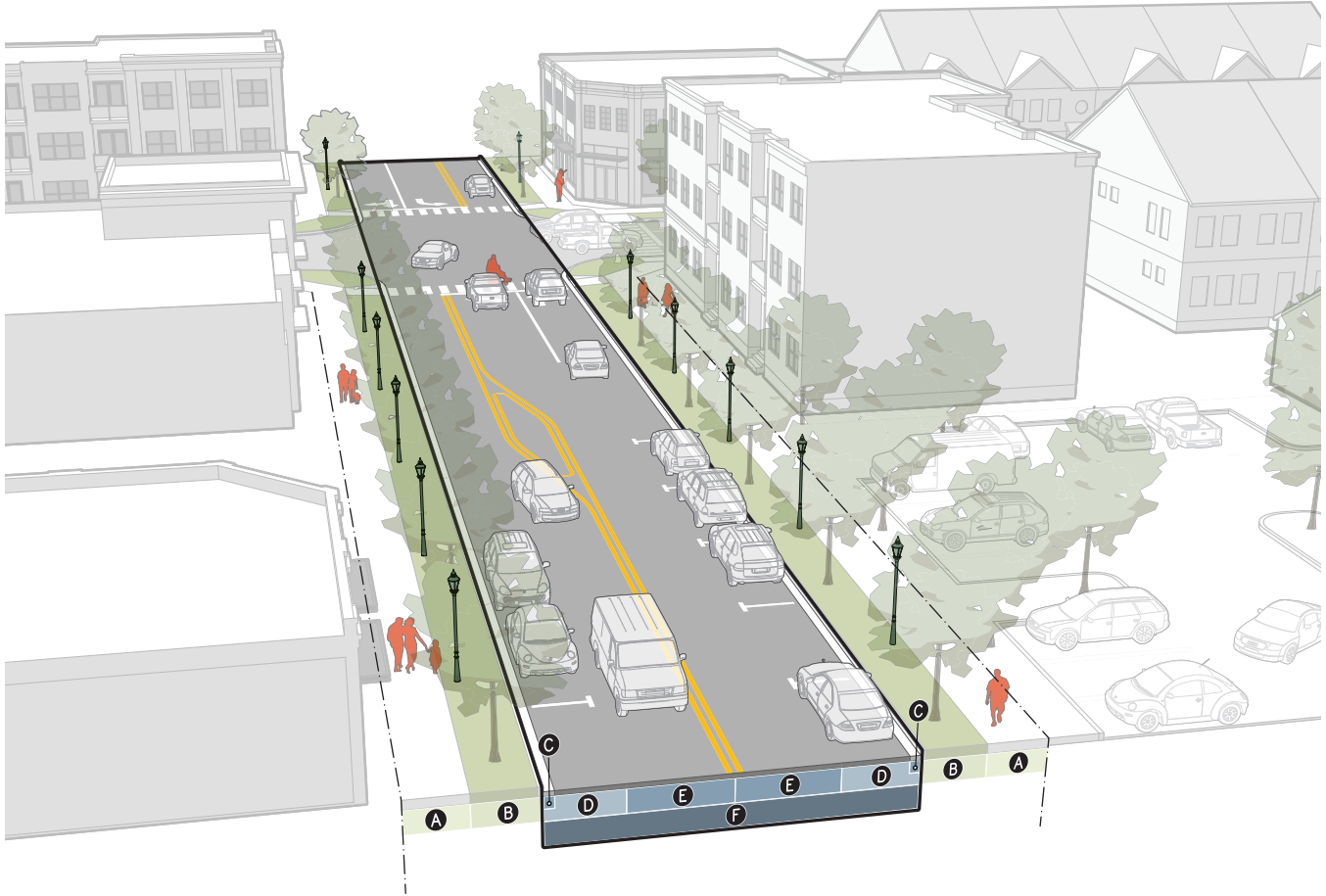

### STREETSCAPE

Ⓐ Pedestrian zone	See Frontage
Ⓑ Furniture zone	See Frontage

### STREET

Ⓒ Gutter pan (min)	1'
Ⓓ Curb lane (min)	8'
Parking (min)	8'
Bulb-outs	Not required
Bike lane (min)	5'*
Bike buffer (min)	2'
Ⓔ Travel lane (min/max)	9'/10'

\*does not include gutter pan

### CONFIGURATIONS

		Ⓕ
No Bike Lane		34' min
With Bike Lane		34' min

## h. Alley



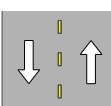

STREETSCAPE	
Pedestrian zone	n/a
Furniture zone	n/a
ALLEY	
<b>A</b> Flush curb (min)	6"
<b>B</b> Travel lane (min/max)	9'/10'

CONFIGURATIONS		<b>C</b>
Min		19'
Max		21'

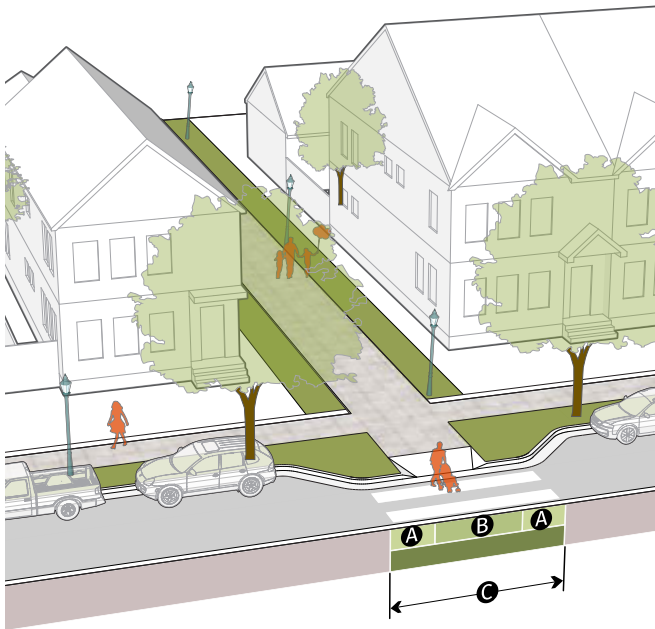
### i. Pedestrian Connection



THROUGH-WAY	
<b>A</b>	Utility zone (cumulative) 7'
<b>B</b>	Pedestrian zone (min)
	Without bike lane 8'
	With bike lanes 5'
<b>B</b>	Bike lanes (min) 10'
CONFIGURATION <b>C</b>	
No Bike Lanes	 15' min
With Bike Lanes	 22' min

### j. Multi-Use Pathway

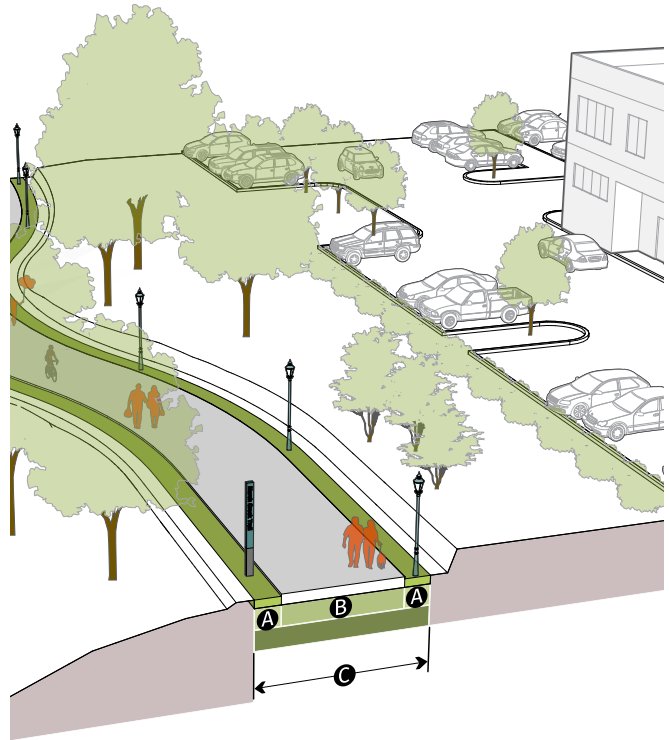

THROUGH-WAY	
<b>A</b>	Utility zone (cumulative) 10'
<b>B</b>	Shared sidewalk/bike zone (min) 15'
CONFIGURATION <b>C</b>	
	 25' min

### 3. Frontage

#### a. Applicability

All Village Core Streets and Village Secondary Streets.

#### b. Standards

##### 1) Core Streets

- a) 20% of all block faces abutting Village Core Streets must meet the frontage requirements of *17.65.30.B, Active Core*.
- b) The remaining portions of block faces abutting Village Core Streets must meet one of the following core frontage requirements:
  - i. *17.65.30.A, Active Core*;
  - ii. *17.65.30.B, Business Core*; or
  - iii. *17.65.30.C, Residential Core*.

##### 2) Non-Core Streets

Block faces abutting non-core streets must meet one of the following frontage requirements:

- a) *17.65.30.A, Active Core*;
- b) *17.65.30.B, Business Core*;
- c) *17.65.30.C, Residential Core*; or
- d) *17.65.30.D, Secondary*.

#### c. Measurement

The minimum percentage of required Active Core is based on the linear length of block frontage abutting the Village Core Streets, measured along the street parcel lines on each side of the street.

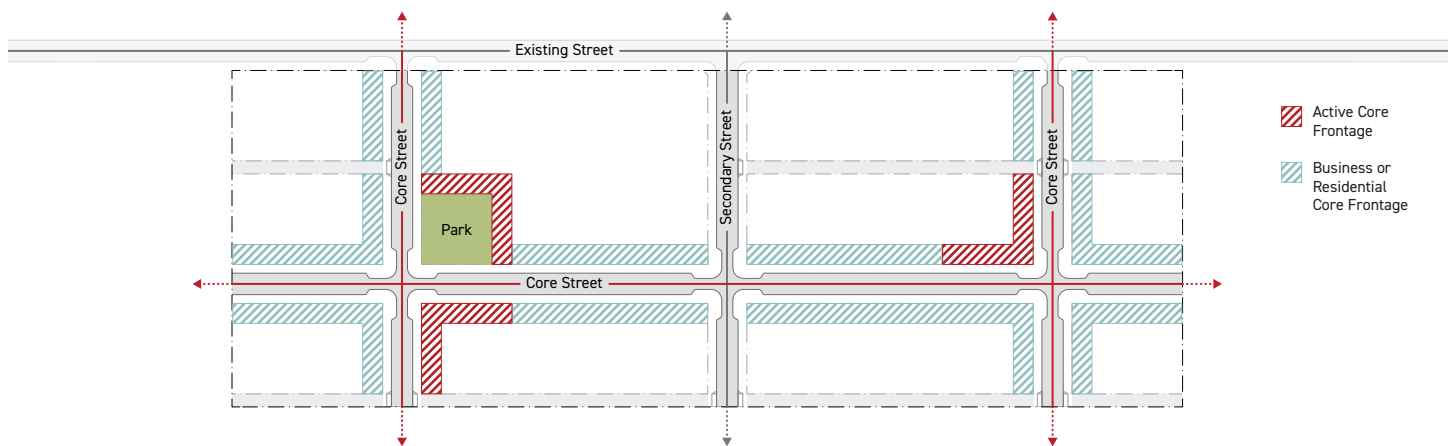

## 4. Open Space

### a. Applicability

All new and existing lots in an Urban Village District.

### b. Standards

- 1) Where open space is required, it must:
  - a) Be located on the development site associated with the project.
  - b) Be located outdoors and open to the sky.
  - c) Not be parked or driven on except for emergency access and permitted temporary events.
  - d) Be a minimum area of 225 square feet with no dimension less than 15 feet.
  - e) Not be located in a required transition area.
  - f) Abut and be directly accessible from a public sidewalk.
  - g) Not be separated from the public sidewalk by any structure for more than 40% of the width, with the exception of a wall or fence with a maximum height of 42 inches.
- 2) For required open space, no less than 40% of its perimeter must abut a Village Core Street and no less than 75% of its perimeter must abut a Village Core frontage or Village Core Street.

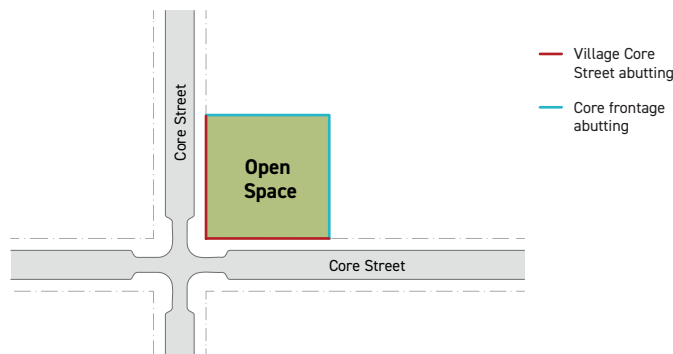

- 3) For any individual open space, seating must be provided at the rate of 1 seat for every 225 square feet and may be permanent or movable for each. Two linear feet of uninterrupted seating area with a minimum depth of 16 inches equals one seat.
- 4) Mechanical and utility equipment cannot be located within required open space.
- 5) Required open space may be either public or private. Privately-owned open space must be made permanently available to the general public, at no cost, between the hours of 5:00 AM and 10:30 PM daily.

- 6) Allowed encroachments into a required open space can cumulatively cover no more than 20% of any individual open space. No allowed encroachment can have a clear height of less than 8 feet, measured from the finished ground surface of the open space.

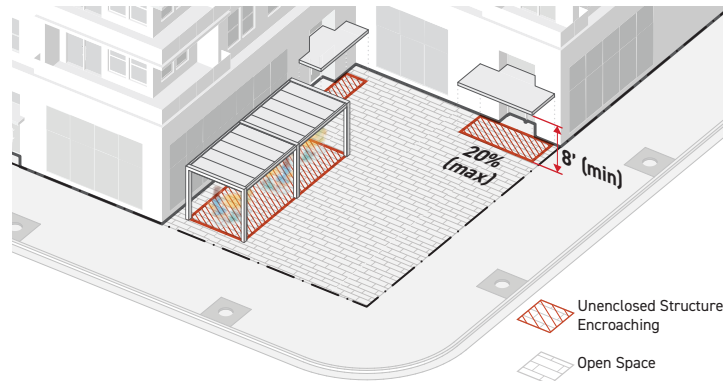

- 7) When the development occurs in phases, each phase must provide at least the percentage of open space that would be required for that phase based on the total area of work.
- 8) All streets abutting open space used to meet the open space requirement must meet 17.65.20.G.2.

**c. Measurement**

The minimum required open space is measured as a percentage of the total site area not including site area dedicated to street right-of-way or public access easements.

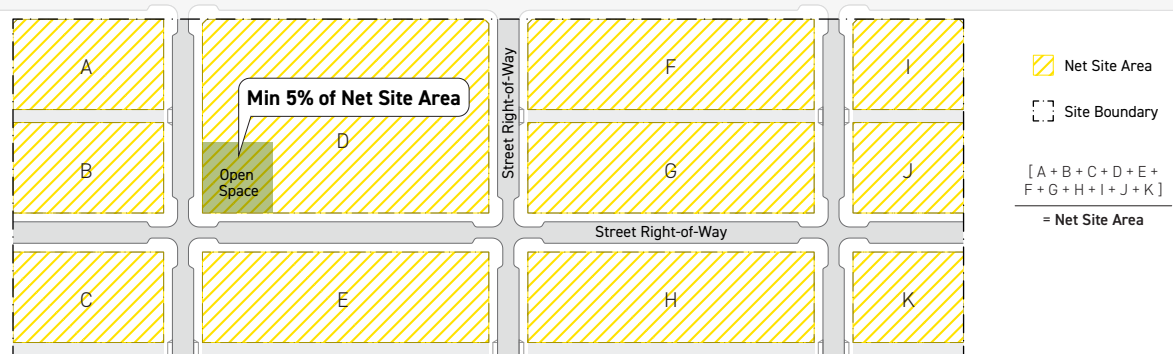

**5. Lot**

- a. For lot width, see 17.08.010. - *Definitions (Lot width)*.
- b. In an Urban Village District, a lot may front on an open space instead of a street, provided the open space meets 17.65.20.G.4, *Open Space*.

**6. Setbacks**

For front line, side line and rear line setbacks, see 17.08.010. - *Definitions (Lot line)*.

## 7. Transitions

### a. Applicability

Any lot that shares a lot line with a Residential District.

### b. Standards

#### 1) General

- a) Where a Type A1 or Type A2 transition is required, it must meet the requirements of this section.
- b) The required transition must be provided along the entire lot line boundary immediately abutting the property line of the abutting Residential District. Breaks for pedestrian, bicycle and vehicle connections are allowed. Driveways or walkways must cross at or near a perpendicular angle.
- c) Required trees and shrubs must be spaced evenly along the entire length of the transition area.
- d) No buildings or structures are allowed in the required transition area, except for a required fence or wall.
- e) All fences and walls provided to meet the transition requirement must meet *17.65.50.H.3, Wall/Fence Design and Installation*.
- f) All trees and shrubs provided to meet the transition requirement must meet *17.65.50.I, Plant Material*.

#### 2) Transition Type A1

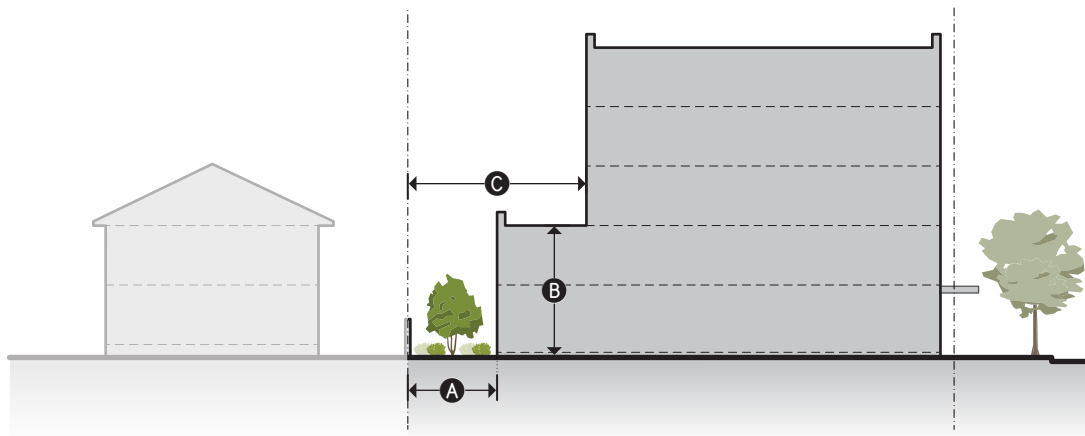

TRANSITION AREA		ADDITIONAL SETBACK	
Ⓐ Depth (min)	15'	Ⓑ Height without additional setback (max)	2 stories / 24'
Small trees (min per 100')	6	Ⓒ Additional setback above 2nd story (min)	30'
Shrubs (min per 100')	75		
Fence or wall height (min)	6'		

### 3) Transition Type A2

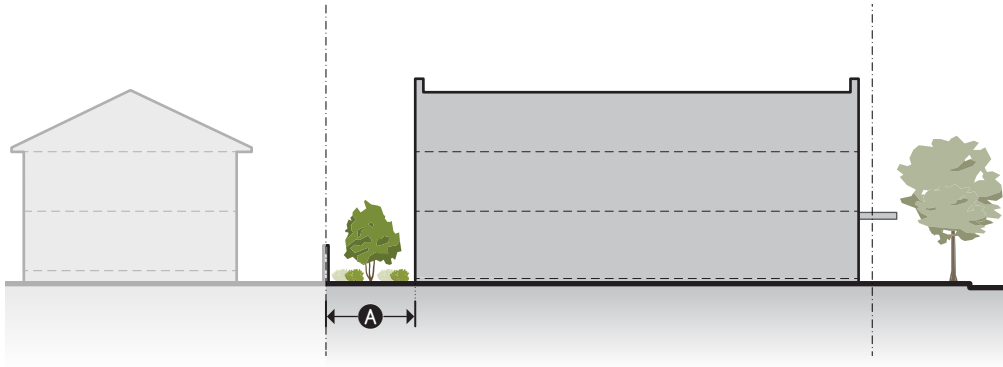

TRANSITION AREA	
<b>A</b> Depth (min)	15'
Small trees (min per 100')	6
Shrubs (min per 100')	75
Fence or wall height (min)	6'

#### c. Measurement

- 1) Transition depth is measured from the shared lot line.
- 2) The additional setback above the 2nd story is measured from the same lot line as transition depth per to the start of the 3rd story building facade. If the entire building is set back away from the lot line, then the building may continue to the maximum height allowed without the additional setback.
- 3) For measurement of maximum height, see *17.65.20.G.8.a*.

## 8. Building

### a. Maximum Height

#### 1) Applicability

All new and existing buildings and structures on a lot.

#### 2) Standards

No building or structure can exceed the maximum number of stories or feet allowed.

#### 3) Measurement

##### a) Height in Feet

For measurement of building height in feet, see *17.08.010. - Definitions (Building Height)*.

##### b) Height in Stories

- i. Height in stories is measured as the number of stories above grade.



- ii. A story is the part of a building included between the surface of one floor and the surface of the next floor above, or if there is no floor above, then the ceiling next above. A mezzanine does not count as a story.
- iii. For the purposes of calculating maximum height in stories:
  - A). The ground story is the first story above grade where the finished ground floor elevation is more than 6 feet above finished grade for any portion of the building perimeter.
  - B). A higher or lower floor may be designated as the ground story for different portions of a building.
  - C). A ground story must be exposed above surrounding grade by at least 6 feet for all portions of the building perimeter.



iv. For the purposes of calculating maximum height in stories, the following does not count as a story:

A). When the attic is completely within the roof form and less than 50% of the floor area has a clear height greater than 7.5 feet, measured from the finished floor to the finished ceiling; or

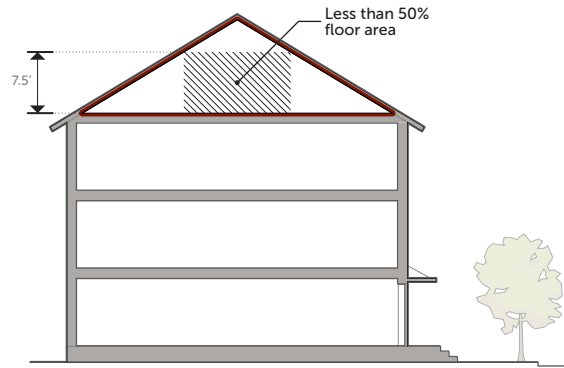

B). A rooftop structure that is used primarily for accessing the roof and the floor area is less than 15% of the floor area of the story immediately below, see also allowed vertical circulation encroachments in 17.65.20.G.8.a.4).

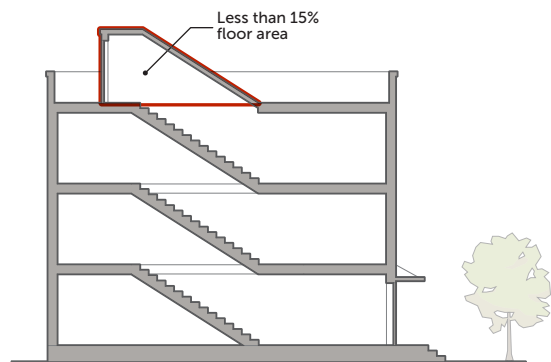

#### 4) Exceptions

The following can exceed the maximum height limit:

<b>Architectural Elements</b>	
<i>Attached to or integrated onto the top of a building, not intended for human occupation. Examples include steeples, spires, belfries, cupolas, domes, flagpoles and lighting.</i>	
Encroachment (max)	10'
Setback from roof edge (min)	0'
<b>Safety Barriers</b>	
<i>Used for safety, screening or protection. Examples include fencing, walls, parapets, railings and stairs.</i>	
Encroachment (max)	6'
Setback from roof edge (min)	0'
<b>Vertical Circulation</b>	
<i>Floor area used only for building circulation and rooftop access. Examples include elevator room (and associated equipment) and stairway access to roof.</i>	
Encroachment (max)	10'
Setback from roof edge (min)	5'
<b>Unenclosed Structures</b>	
<i>Attached to or integrated onto the roof of a building, intended for human shelter or activity. Examples include shade structures, cabanas, pergolas, rooftop bar, outdoor dining, permanent seating, beehives, sports courts and cooking facilities.</i>	
Encroachment (max)	8'
Setback from roof edge (min)	5'
<b>Rooftop Equipment</b>	
<i>Supported by a roof related to public or privately-operated systems, including related wires, conduits, pipes and visual screens. Examples include HVAC equipment, cisterns, water tanks, wind turbines, solar panels, solar water heaters, exhaust ducts, smokestacks, satellite dishes, ventilation fans, chimney, flues, vent stacks, generators)</i>	
Encroachment (max)	10'
Setback from roof edge (min)	5'
<b>Flatwork</b>	
<i>Objects 2.5 feet in height or less. Examples include decking, walkways, patios.</i>	
Encroachment (max)	2.5'
Setback from roof edge (min)	1'
<b>Vegetation</b>	
<i>Living organisms, absorbing water and organic substances through its roots and synthesizing nutrients. Examples include trees, shrubs, flowers, herbs, vegetables, grasses, ferns, mosses and associated planters and raised planting beds, if applicable.</i>	
Encroachment (max)	unlimited
Setback from roof edge (min)	1'

## b. Minimum Height

### 1) Applicability

All new buildings along a Village Core Street.

### 2) Standards

A least 75% of the required Village Core Street build-to width, measured cumulatively, must meet the required minimum building height for a depth equal to the required occupiable depth.

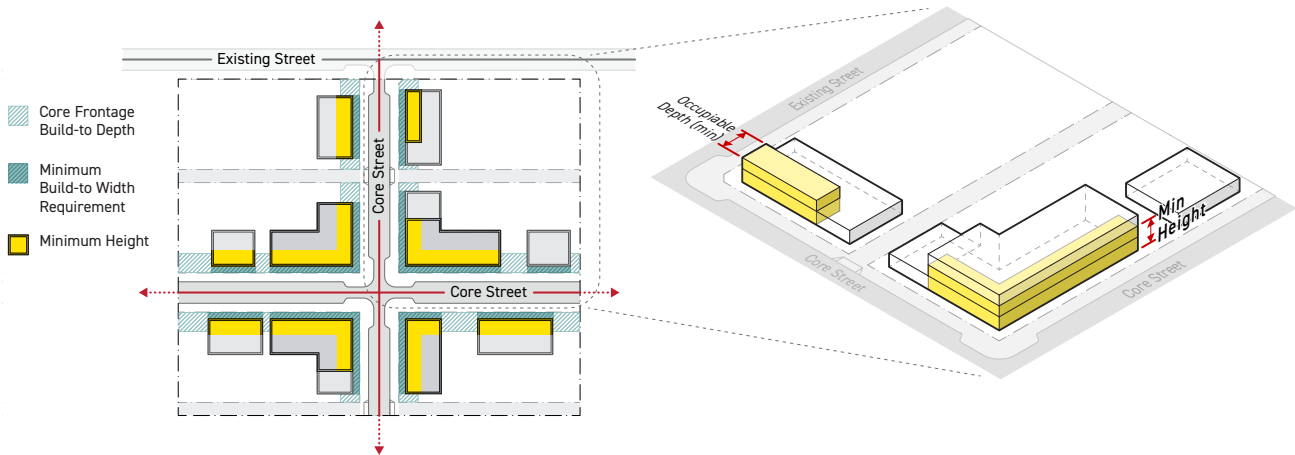

### 3) Measurement

- For measurement of building height, see 17.65.20.G.8.a.
- For measurement of build-to width, see 17.65.30.I.2.b.
- For measurement of occupiable depth, see 17.65.30.I.2.c.

## c. Width

### 1) Applicability

All buildings on the lot that face a street.

### 2) Standards

- No building can be wider than the maximum allowed building width.
- Two buildings can abut one another provided they have no shared components (including but not limited to footings, slab and walls) and have no shared circulation.

### 3) Exceptions

An open space meeting the following standards may be used to establish a continuous structure as separate buildings for the purpose of meeting a maximum building width requirement:

- a) The width of the open space can be no more than  $\frac{1}{2}$  the width of the widest adjacent building width provided and no less than  $\frac{1}{4}$  the width of widest adjacent building width provided.
- b) The depth of the open space must be at least 1.5 times the width of the open space.
- c) A maximum of 1 open space can be used for each building.

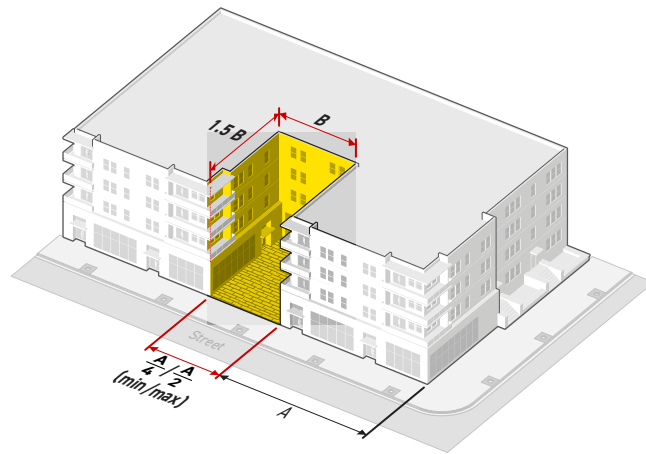

### 4) Measurement

Building width is measured horizontally and parallel to each front lot line from one end of an applicable building or collection of buildings to the opposite end.

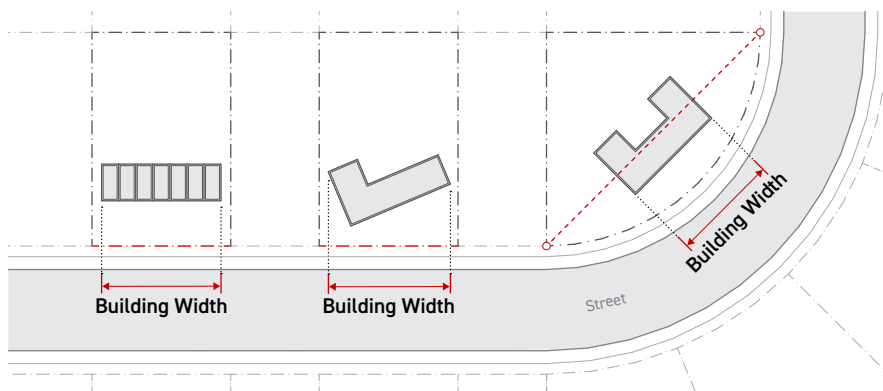

## H. Allowed Uses

The following uses are permitted by-right (P) or may be allowed by Special Use Permit (S) if approved by the Planning Board as part of unified development review (see 17.65.60.A, *Land Development Project*). A (--) in table cell means the use is not allowed.

	UV-5	UV-3	BC-3	MT-3	MK-3	WC-3
<b>1. RESIDENTIAL USES</b>						
Single-family dwelling	--	--	--	--	--	--
Two-family dwelling	--	--	--	--	--	--
Multifamily dwellings, Live-work dwellings						
Up to 35% of total gross square footage for the entire project	P	P	--	--	--	S
More than 35% of total gross square footage for the entire project	S	S	--	--	--	S
Home occupation	P	P	--	--	--	--
Family day care home	P	P	--	--	--	--
Community residence	P	P	--	--	--	--
Convalescent home, rest home	P	P	--	--	--	--
Nonprofit multifamily housing facilities for the elderly and/or handicapped	P	P	--	--	--	--
Temporary housing for yachting organizations	S	S	--	--	--	--
<b>2. PUBLIC/CIVIC USES</b>						
Agricultural and horticultural society	S	S	S	S	--	S
Bird sanctuary	--	--	--	--	--	--
Bus terminal	S	S	S	S	S	--
Cemetery	--	--	--	--	--	--
Church; place of worship	P	P	P	P	P	P
Conservation land	P	P	P	P	P	P
Cultural institution	P	P	P	P	--	P
Federal, state and municipal building	S	S	S	S	S	S
Golf courses (including miniature golf courses and commercial driving ranges)	--	--	--	--	--	--
Hospital	S	S	--	--	--	--
Library	P	P	S	S	S	P
Multi-modal transportation facility	S	S	S	S	S	S
Municipal and public service corporation building and facility	P	P	P	P	P	P
Museum	P	P	S	S	--	P
Nursery school, day care center	P	P	P	--	--	-
Open space, park, playground, playing field, plaza, trail	P	P	P	P	P	P
Natural beach swimming area, both public and private	--	--	--	--	--	P

P = Permitted by-right    S = Special Use Permit Required    -- = Use Not Permitted

	UV-5	UV-3	BC-3	MT-3	MK-3	WC-3
Religious, philanthropic, scientific, literary, historical, fraternal, and charitable institution	S	S	S	S	--	P
Schools, colleges and universities including fraternity or sorority houses or dormitories for faculty or students	S	S	S	S	--	S
Schools of limited instruction	S	S	S	P	P	S
Wildlife preserve	--	--	--	--	--	--
<b>3. COMMERCIAL USES</b>						
Arcade	--	--	--	--	--	--
Automobile repair shop	--	--	--	--	S	--
Automobile washing and cleaning establishment	--	--	--	--	S	--
Clubs for outdoor recreation	--	--	--	--	--	S
Commercial indoor recreational facility	P	P	P	--	--	P
Commercial outdoor recreation facility	S	S	S	--	--	S
Commercial parking lot	--	--	--	--	--	--
Day camps for children and youth	--	--	--	--	--	S
Drive-in restaurants in a shopping center	--	--	--	--	--	--
Drive-thru facility	--	--	--	--	--	--
Fast-food restaurants	P	P	P	--	--	S
Guest house	--	--	--	--	--	--
Historic guest house	--	--	--	--	--	--
Gasoline filling station (with minor repairing)	--	--	S	--	--	--
Horses or ponies for hire; riding academies or boarding stables	--	--	--	--	--	--
Horse-riding academies and boarding stables for horses	--	--	--	--	--	--
Parking garage	S	S	--	--	--	--
Shopping center	--	--	--	--	--	--
Standard restaurant	P	P	P	--	--	S
Store where goods are sold or service is rendered primarily at retail	P	P	P	--	--	S
Store where nautical goods are sold or nautical services rendered at retail	P	P	P	--	--	S
Tavern	P	P	P	--	--	S
Theater	P	P	P	--	--	P
Transient guest facility:						
Up 100 rooms for the entire project	P	P	--	--	--	--
More than 100 rooms for the entire project	S	S	--	--	--	--
Undertaker's establishment	--	--	--	--	--	--
Vacation guest facility	S	S	--	--	--	--
Wholesale brewing, distilling, fermenting, fungiculture or hydroponics	S	S	S	P	P	S

P = Permitted by-right    S = Special Use Permit Required    -- = Use Not Permitted

	UV-5	UV-3	BC-3	MT-3	MK-3	WC-3
<b>4. EMPLOYMENT USES</b>						
Advanced manufacturing	P	P	P	P	--	S
Banks and financial institution	P	P	P	P	--	S
Convention or conference center	P	P	P	--	--	S
Co-working space	P	P	P	P	--	S
Maker space	P	P	P	P	P	S
Marine and oceanographic research laboratory	P	P	P	P	--	P
Professional and business office	P	P	P	P	--	P
Professional and business offices where maritime issues and products are the primary use, i.e., naval architects, maritime publishers, etc.	P	P	P	P	--	P
Research and development facilities, including but not limited to clean energy, defense systems, ocean technologies, medical and pharmaceutical, and digital industries	P	P	P	P	--	P
Research laboratory	P	P	P	P	--	P
<b>5. MARINE USES</b>						
Boat building and repair	--	--	P	P	P	S
Boat dealer and broker	--	--	P	P	P	--
Boating instruction	--	--	--	--	--	P
Commercial marine oriented recreation facilities including boat shows, sightseeing tours, and sport fishing charters	--	--	--	--	--	P
Docks, slips and piers where boats may be berthed provided that the parcel of land is adjacent to an open water body	--	--	--	--	--	S
Facilities for marine pollution control, oil spill clean-up and services of marine sanitation devices	--	--	--	--	--	--
Marina	--	--	--	--	--	P
Marine fabrication, including sail making, canvas manufacturing, and marine metal casting	--	--	P	P	P	--
Marine salvage and vessel towing service	--	--	--	--	--	--
Marine transport operations, including shipping offices	--	--	--	--	--	--
On land boat storage during the non-boating season	--	--	--	--	--	--
Yacht and sailing clubs, and schools which give special marine or nautical instruction	P	P	P	P	--	P

P = Permitted by-right    S = Special Use Permit Required    -- = Use Not Permitted



	UV-5	UV-3	BC-3	MT-3	MK-3	WC-3
<b>6. INDUSTRIAL USES</b>						
Business and storage yard for lumber and building material	--	--	--	--	P	--
Bulk storage of cement and petroleum products; concrete mixing plants; bituminous paving mixing plants	--	--	--	--	--	--
Commercial scale energy system	S	S	S	S	S	S
Commercial transmitting and receiving antennas, with enclosures for associated equipment	--	--	--	--	--	--
Community water supply reservoir	--	--	--	--	--	--
Community well house	--	--	--	--	--	--
Contractors warehouse and storage yard	--	--	--	--	P	--
Commercial storage and sale of fuel and bottled gas	--	--	--	--	S	--
Earth removal and paving contractor's business and storage yard	--	--	--	--	P	--
Farms, truck gardens, nurseries, forestry (excluding the keeping of livestock and poultry for commercial purposes)	--	--	--	--	--	--
Fish and seafood receiving, handling, storage and shipping	--	--	--	--	P	--
Freight and materials trucking business and terminals	--	--	--	--	--	--
Indoor motor vehicle storage facility - only light maintenance of the vehicles stored is allowed	--	--	--	--	P	--
Laundry, cleaning, and dyeing plant	--	--	--	--	P	--
Manufacturing, processing, assembly or storage of goods	--	--	--	P	P	--
Painting and woodworking shop	P	P	P	P	P	--
Plant for the processing and distribution of milk and edible dairy products; plant for the packaging and distribution of beverages	--	--	--	--	--	--
Printing and publishing establishment	S	S	P	P	P	--
Public utilities - private electrical services	S	S	S	S	S	S
Radio and television broadcasting studio (excluding transmitting and receiving towers)	S	S	P	P	P	S
Residential scale wind energy system	S	S	S	S	S	S
Seafood sales, landing, storage, brokerage and distribution	--	--	--	P	P	--
Sheet metal, blacksmith, welding; tire recapping; machine shops and the like	--	--	--	P	P	--
Warehousing, wholesale business; and wholesale business warehousing	--	--	--	P	P	--
Water and sewage treatment facility	--	--	--	--	--	--
Water and sewage pumping station	--	--	--	--	--	--
Water tower	S	S	S	S	S	S

P = Permitted by-right    S = Special Use Permit Required    -- = Use Not Permitted

# 17.65.30. FRONTAGE OVERLAYS

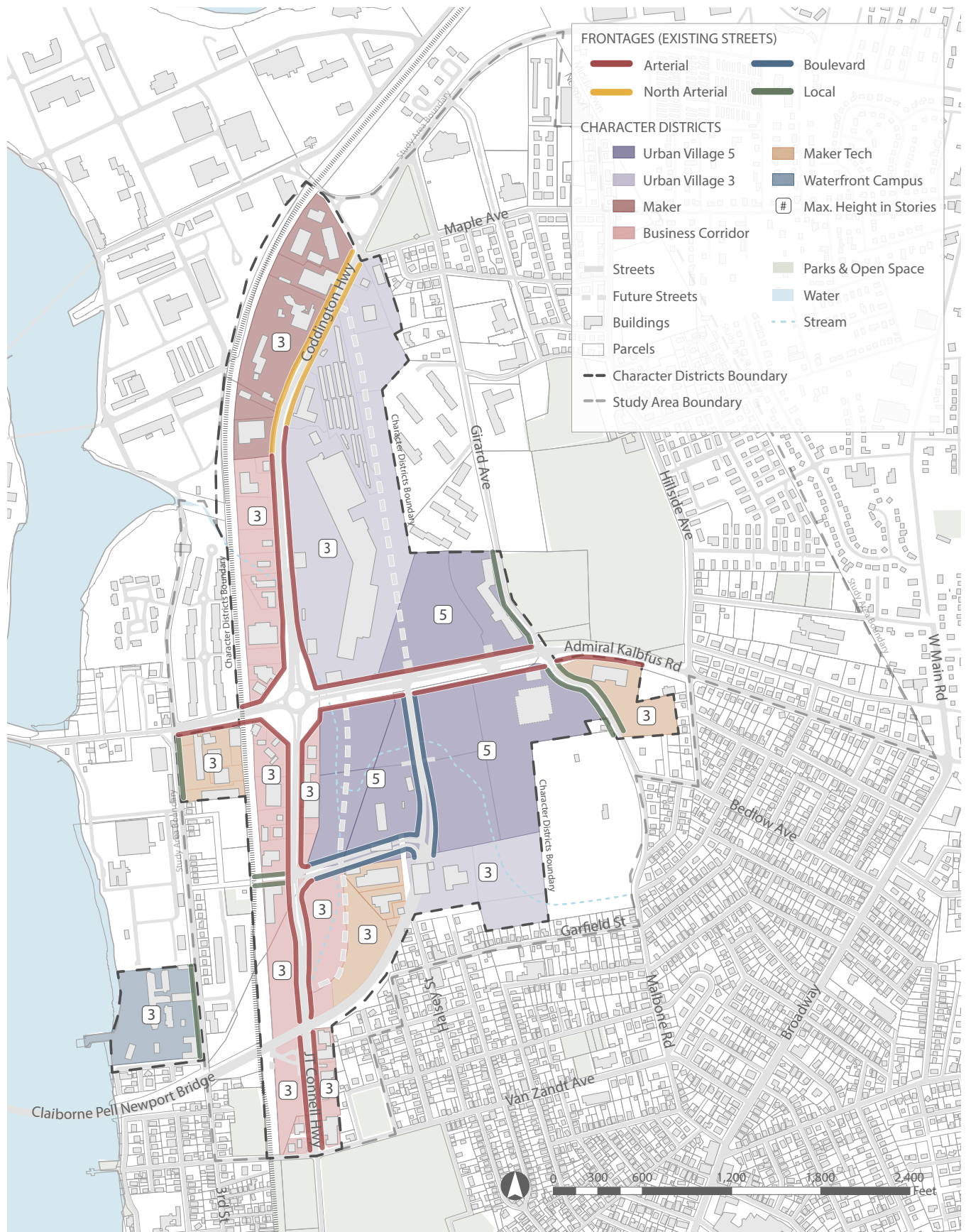

## A. Active Core

The Active Core Frontage provides for a high-quality active and walkable environment along Village Core Streets within an Urban Village District. The requirements generate buildings primarily with ground floor retail uses with office or residential space above (although all uses allowed in the zoning district may occur).

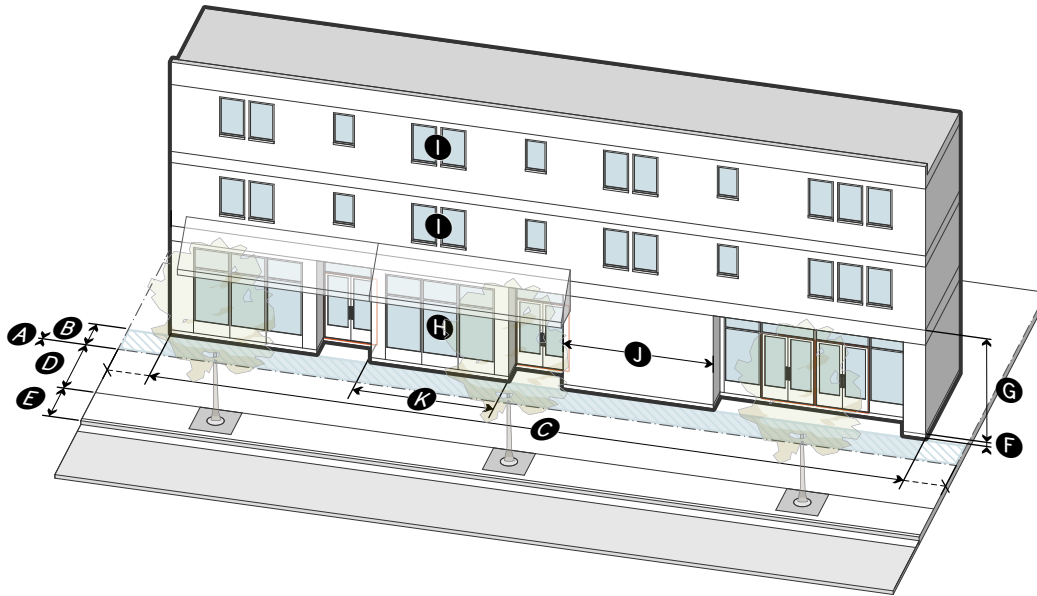

<b>1. BUILD-TO</b>	<i>17.65.30.1.2</i>	<b>4. STORY HEIGHT</b>	<i>17.65.30.1.5</i>
<b>A</b> Front line setback (min)	0'	<b>F</b> Ground floor elevation (min/max)	0'/2'
<b>B</b> Depth (max)	5'	<b>G</b> Ground story height (min)	14'
<b>C</b> Width (min)	90%	<b>5. TRANSPARENCY</b>	<i>17.65.30.1.6</i>
Occupiable depth (min)	20'	<b>H</b> Ground story (min)	70%
<b>2. PARKING LOCATION</b>	<i>17.65.30.1.3</i>	<b>I</b> Upper story (min)	20%
No parking between building and street		<b>J</b> Blank wall width (max)	15'
Required parking screen	Type B1	<b>6. PEDESTRIAN ACCESS</b>	<i>17.65.30.1.7</i>
<b>3. STREETScape</b>	<i>17.65.30.1.4</i>	<b>K</b> Street-facing entrance spacing (max)	30'
<b>D</b> Pedestrian zone (min)	10'	<b>7. VEHICLE ACCESS</b>	<i>17.65.30.1.8</i>
<b>E</b> Furniture zone (min)	6'	Number of driveways (max)	0
Tree planting type	Pits		
Tree planting	35' avg on-center		
Wall and fence type allowed	Type C1		

## B. Business Core

The Business Core Frontage provides for a high-quality walkable environment along Village Core Streets within an Urban Village District. The requirements generate buildings primarily for office use (although all uses allowed in the zoning district may occur).

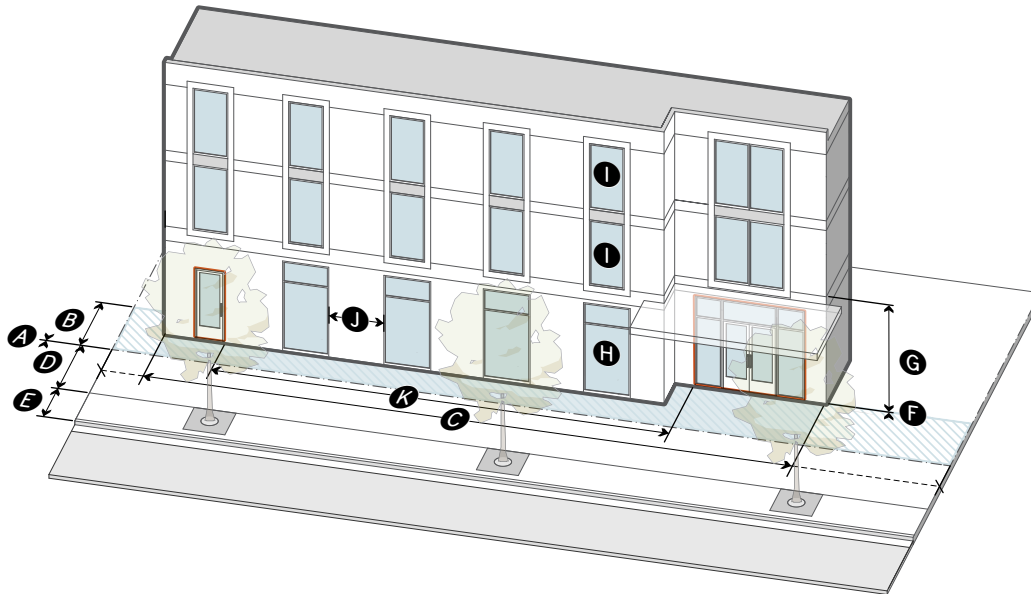

<b>1. BUILD-TO</b>	<i>17.65.30.1.2</i>	<b>4. STORY HEIGHT</b>	<i>17.65.30.1.5</i>
<b>A</b> Front line setback (min)	0'	<b>F</b> Ground floor elevation (min/max)	0'/2'
<b>B</b> Depth (max)	10'	<b>G</b> Ground story height (min)	12'
<b>C</b> Width (min)	80%	<b>5. TRANSPARENCY</b>	<i>17.65.30.1.6</i>
Occupiable depth (min)	20'	<b>H</b> Ground story (min)	50%
<b>2. PARKING LOCATION</b>	<i>17.65.30.1.3</i>	<b>I</b> Upper story (min)	20%
No parking between building and street		<b>J</b> Blank wall width (max)	20'
Required parking screen	Type B1	<b>6. PEDESTRIAN ACCESS</b>	<i>17.65.30.1.7</i>
<b>3. STREETScape</b>	<i>17.65.30.1.4</i>	<b>K</b> Street-facing entrance spacing (max)	50'
<b>D</b> Pedestrian zone (min)	8'	<b>7. VEHICLE ACCESS</b>	<i>17.65.30.1.8</i>
<b>E</b> Furniture zone (min)	6'	Number of driveways (max)	1 per block
Tree planting type	Lawn or pits	Distance from intersection (min)	75'
Tree planting	35' avg on-center	Number of lanes (max)	2
Wall and fence type allowed	Type C1	Lane width (min/max)	8'/10'

## C. Residential Core

The Residential Core Frontage provides for a high-quality walkable environment along Village Core Streets within an Urban Village District. The requirements generate buildings primarily for residential use (although all uses allowed in the zoning district may occur).

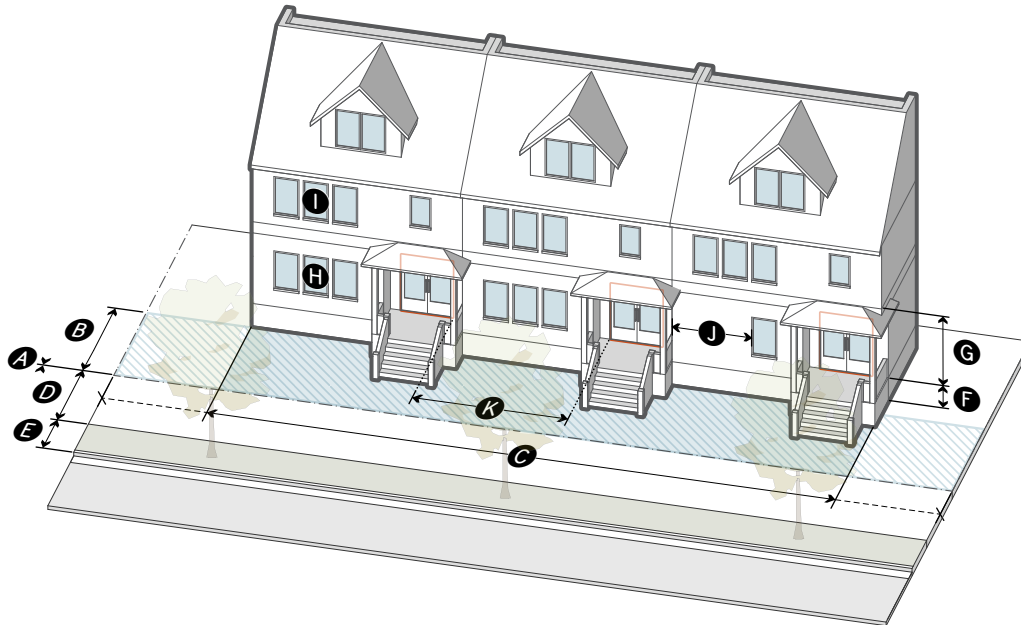

<b>1. BUILD-TO</b>	<i>17.65.30.1.2</i>	<b>4. STORY HEIGHT</b>	<i>17.65.30.1.5</i>
<b>A</b> Front line setback (min)	0'	<b>F</b> Ground floor elevation (min/max)	0'/4'
<b>B</b> Depth (max)	15'	<b>G</b> Ground story height (min)	10'
<b>C</b> Width (min)	70%	<b>5. TRANSPARENCY</b>	<i>17.65.30.1.6</i>
Occupiable depth (min)	15'	<b>H</b> Ground story (min)	20%
<b>2. PARKING LOCATION</b>	<i>17.65.30.1.3</i>	<b>I</b> Upper story (min)	20%
No parking between building and street		<b>J</b> Blank wall width (max)	15'
Required parking screen	Type B1	<b>6. PEDESTRIAN ACCESS</b>	<i>17.65.30.1.7</i>
<b>3. STREETScape</b>	<i>17.65.30.1.4</i>	<b>K</b> Street-facing entrance spacing (max)	40'
<b>D</b> Pedestrian zone (min)	8'	<b>7. VEHICLE ACCESS</b>	<i>17.65.30.1.8</i>
<b>E</b> Furniture zone (min)	6'	Number of driveways (max)	1 per block
Tree planting type	Lawn or pits	Distance from intersection (min)	75'
Tree planting	35' avg on-center	Number of lanes (max)	1
Wall and fence type allowed	Type C2	Lane width (min/max)	8'/10'

## D. Secondary

The Secondary Frontage provides for a walkable environment along Village Secondary Streets within an Urban Village District. The requirements generate buildings primarily for retail or office use (although all uses allowed in the zoning district may occur).

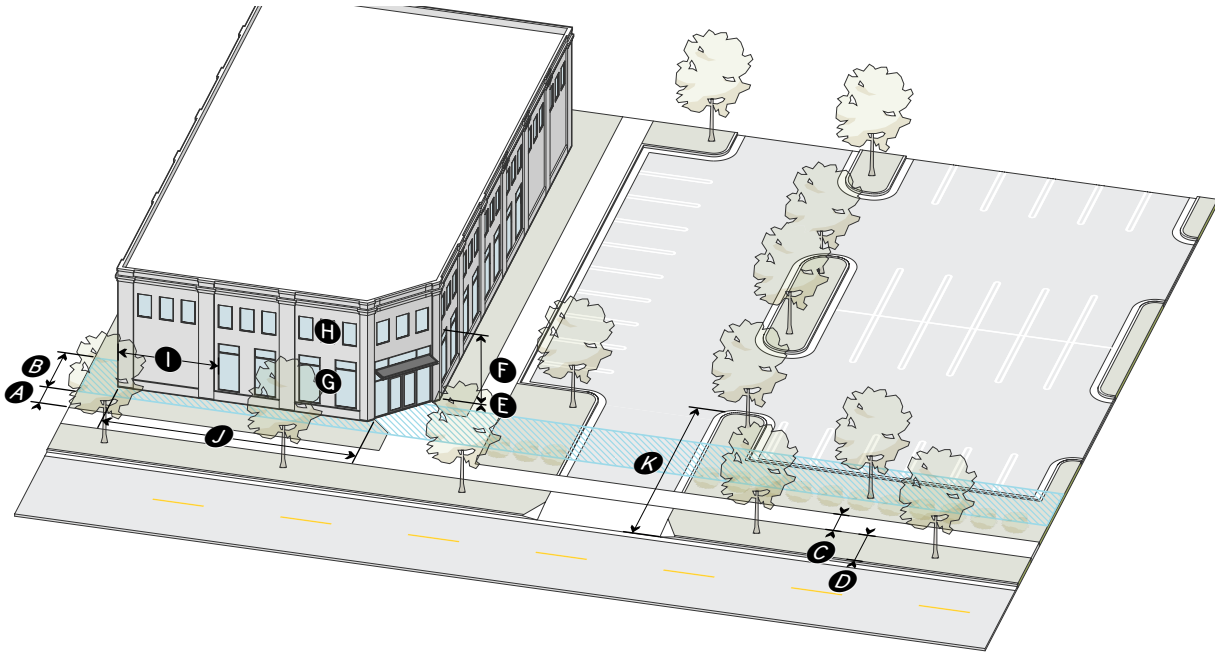

<b>1. BUILD-TO</b>	<i>17.65.30.1.2</i>	<b>4. STORY HEIGHT</b>	<i>17.65.30.1.5</i>
<b>A</b> Front line setback (min)	5'	<b>E</b> Ground floor elevation (min/max)	0'/4'
<b>B</b> Depth (max)	15'	<b>F</b> Ground story height (min)	10'
Width (min)	n/a	<b>5. TRANSPARENCY</b>	<i>17.65.30.1.6</i>
Occupiable depth (min)	15'	<b>G</b> Ground story (min)	40%
<b>2. PARKING LOCATION</b>	<i>17.65.30.1.3</i>	<b>H</b> Upper story (min)	20%
No parking between building and street		<b>I</b> Blank wall width (max)	30'
Required parking screen	Type B1 or B2	<b>6. PEDESTRIAN ACCESS</b>	<i>17.65.30.1.7</i>
<b>3. STREETScape</b>	<i>17.65.30.1.4</i>	<b>J</b> Street-facing entrance spacing (max)	60'
<b>C</b> Pedestrian zone (min)	6'	<b>7. VEHICLE ACCESS</b>	<i>17.65.30.1.8</i>
<b>D</b> Furniture zone (min)	6'	Number of driveways (max)	1 per block
Tree planting type	Lawn	Distance from intersection (min)	75'
Tree planting	35' avg on-center	Number of lanes (max)	2
Wall and fence type allowed	Type C2	Lane width (min/max)	8'/10'
		<b>K</b> Throat depth (min)	40'

## E. Arterial

The Arterial Frontage provides for a walkable environment along major corridors. An environment that balances the auto-dominant nature of the corridor with that of pedestrians. The requirements generate buildings primarily for retail or office use (although all uses allowed in the zoning district may occur).

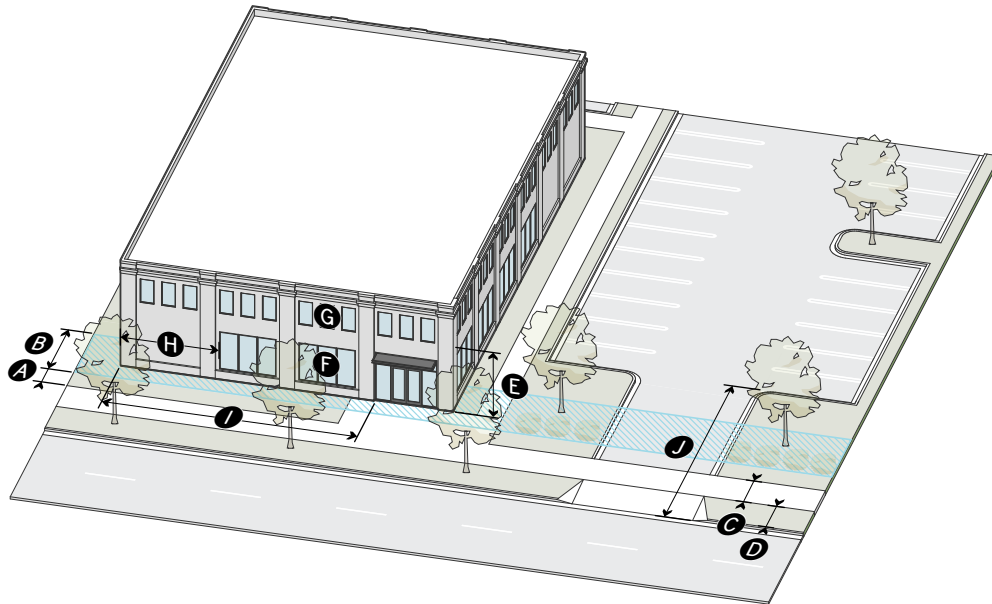

<b>1. BUILD-TO</b>	<i>17.65.30.1.2</i>	<b>4. STORY HEIGHT</b>	<i>17.65.30.1.5</i>
<b>A</b> Front line setback (min)	5'	Ground floor elevation (min/max)	n/a
<b>B</b> Depth (max)	15'	<b>E</b> Ground story height (min)	10'
Width (min)	n/a	<b>5. TRANSPARENCY</b>	<i>17.65.30.1.6</i>
Occupiable depth (min)	15'	<b>F</b> Ground story (min)	40%
<b>2. PARKING LOCATION</b>	<i>17.65.30.1.3</i>	<b>G</b> Upper story (min)	20%
No parking between building and street		<b>H</b> Blank wall width (max)	30'
Required parking screen	Type B2	<b>6. PEDESTRIAN ACCESS</b>	<i>17.65.30.1.7</i>
<b>3. STREETScape</b>	<i>17.65.30.1.4</i>	<b>I</b> Street-facing entrance spacing (max)	75'
<b>C</b> Pedestrian zone (min)	8'	<b>7. VEHICLE ACCESS</b>	<i>17.65.30.1.8</i>
<b>D</b> Furniture zone (min)	8'	Driveway spacing (min)	200'
Tree planting type	Lawn	Distance after intersection (min)	100'
Tree planting	35' avg on-center	Distance before intersection (min)	200'
Wall and fence type allowed	Type C2 and C3	Number of lanes (max)	2
		Lane width (min/max)	8'/12'
		<b>J</b> Throat depth (min)	40'

## F. North Arterial

The North Arterial Frontage provides for a walkable environment along major corridors. An environment that balances the auto-dominant nature of the corridor with that of pedestrians. The requirements generate buildings primarily for industrial use (although all uses allowed in the zoning district may occur).

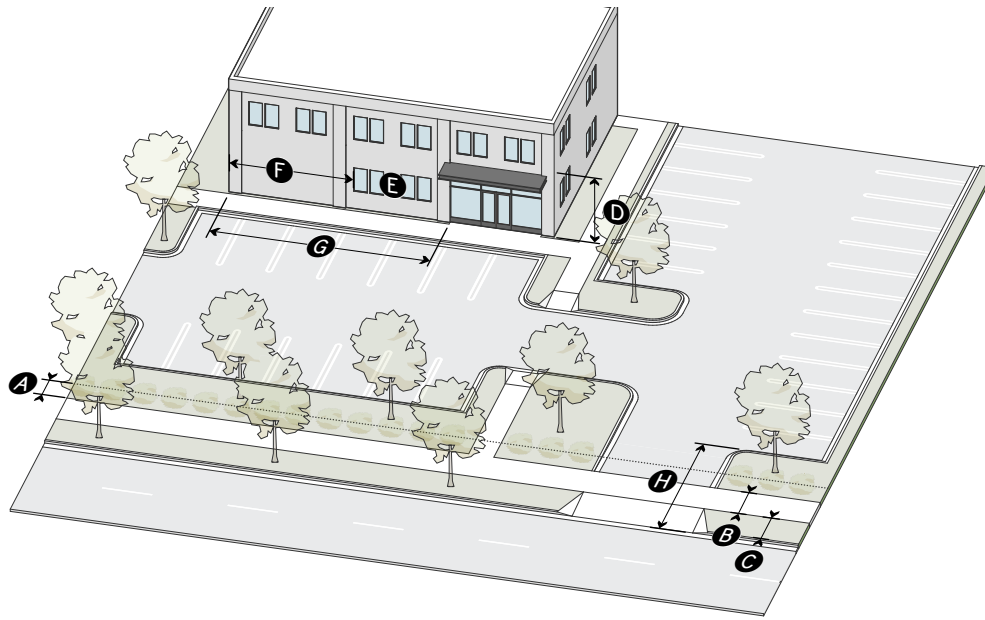

<b>1. BUILD-TO</b>	17.65.30.1.2	<b>4. STORY HEIGHT</b>	17.65.30.1.5
<b>A</b> Front line setback (min)	5'	Ground floor elevation (min/max)	n/a
<b>2. PARKING LOCATION</b>	17.65.30.1.3	<b>D</b> Ground story height (min)	10'
Parking allowed between building and street		<b>5. TRANSPARENCY</b>	17.65.30.1.6
Required parking screen	Type B2	<b>E</b> Ground story (min)	20%
<b>3. STREETScape</b>	17.65.30.1.4	Upper story (min)	n/a
<b>B</b> Pedestrian zone (min)	6'	<b>F</b> Blank wall width (max)	50'
<b>C</b> Furniture zone (min)	8'	<b>6. PEDESTRIAN ACCESS</b>	17.65.30.1.7
Tree planting type	Lawn	<b>G</b> Street-facing entrance spacing (max)	200'
Tree planting	35' avg on-center	<b>7. VEHICLE ACCESS</b>	17.65.30.1.8
Wall and fence type allowed	Type C3	Driveway spacing (min)	200'
		Distance after intersection (min)	100'
		Distance before intersection (min)	200'
		Number of lanes (max)	2
		Lane width (min/max)	8'/14'
		Throat depth (min)	40'



## G. Boulevard

The Boulevard Frontage provides for a walkable environment along a major gateway into the North End. An environment that balances the need for efficient traffic flow with that of pedestrian activity in the abutting Urban Village. The requirements generate buildings primarily for retail or office use (although all uses allowed in the zoning district may occur).

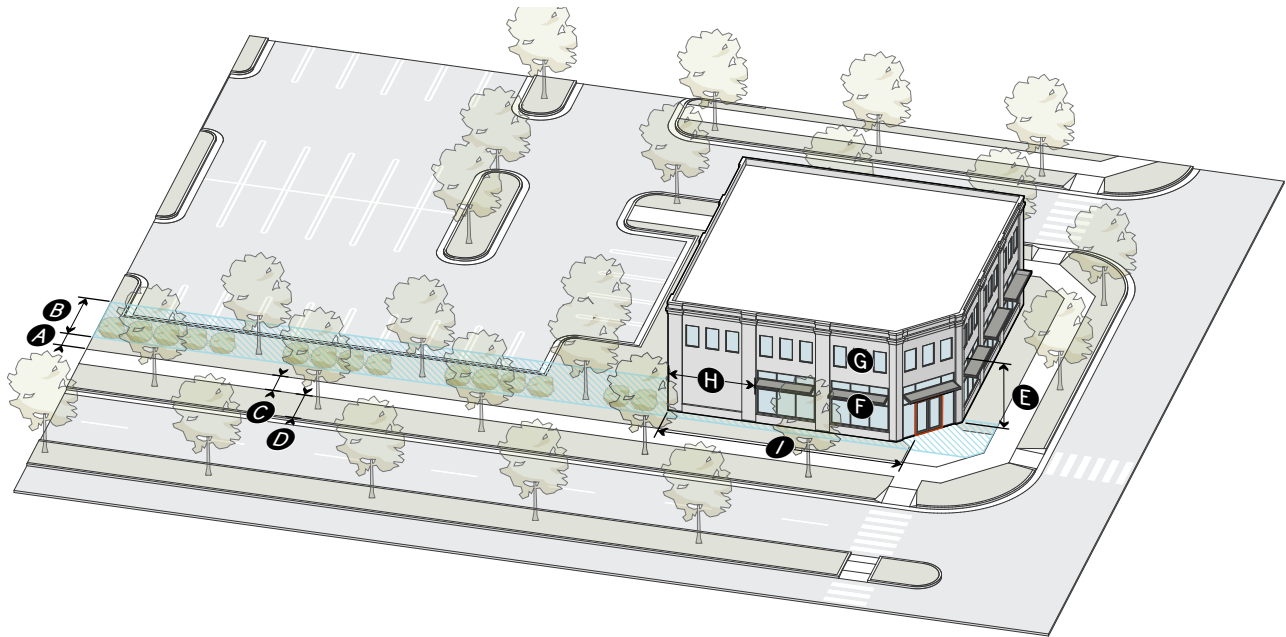

<b>1. BUILD-TO</b>	<i>17.65.30.1.2</i>	<b>4. STORY HEIGHT</b>	<i>17.65.30.1.5</i>
<b>A</b> Front line setback (min)	5'	Ground floor elevation (min/max)	n/a
<b>B</b> Depth (max)	15'	<b>E</b> Ground story height (min)	10'
Width (min)	n/a	<b>5. TRANSPARENCY</b>	<i>17.65.30.1.6</i>
Occupiable depth (min)	20'	<b>F</b> Ground story (min)	40%
<b>2. PARKING LOCATION</b>	<i>17.65.30.1.3</i>	<b>G</b> Upper story (min)	20%
No parking between building and street		<b>H</b> Blank wall width (max)	30'
Frontage screen	Type B1 or B2	<b>6. PEDESTRIAN ACCESS</b>	<i>17.65.30.1.7</i>
<b>3. STREETScape</b>	<i>17.65.30.1.4</i>	<b>I</b> Street-facing entrance spacing (max)	100'
<b>C</b> Pedestrian zone (min)	8'	<b>7. VEHICLE ACCESS</b>	<i>17.65.30.1.8</i>
<b>D</b> Furniture zone (min)	6'	Number of driveways (max)	0
Tree planting type	Lawn		
Tree planting	35' avg on-center		
Wall and fence type	Type C2		

# H. Local

The Local Frontage provides for a walkable environment along local roadways. The requirements generate buildings primarily for retail or office use (although all uses allowed in the zoning district may occur).

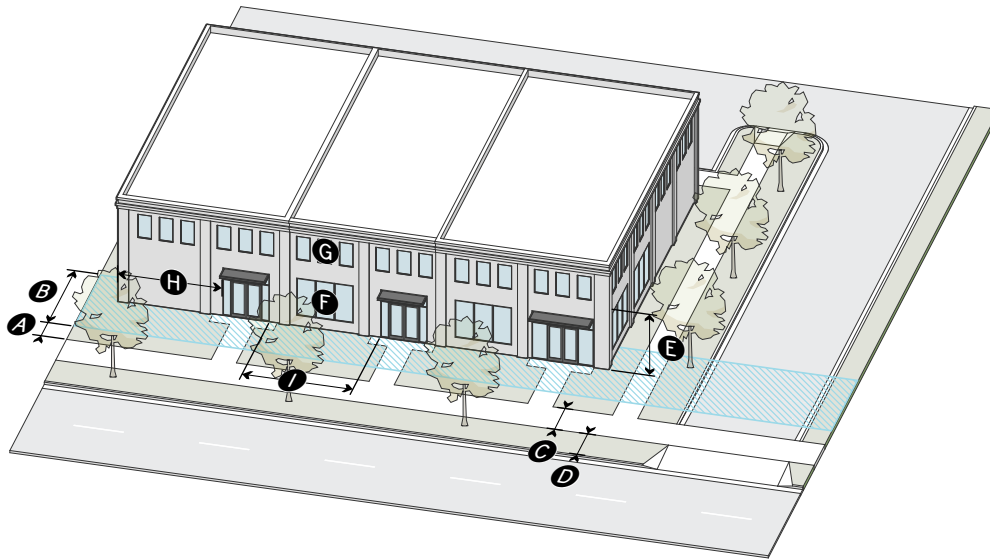

<b>1. BUILD-TO</b>	<i>17.65.30.1.2</i>
<b>A</b> Front line setback (min)	5'
<b>B</b> Depth (max)	20'
Width (min)	n/a
Occupiable depth (min)	15
<b>2. PARKING LOCATION</b>	<i>17.65.30.1.3</i>
No parking between building and street	
Frontage screen	Type B1 or B2
<b>3. STREETScape</b>	<i>17.65.30.1.4</i>
<b>C</b> Pedestrian zone (min)	6'
<b>D</b> Furniture zone (min)	6'
Tree planting type	Lawn
Tree planting	35' avg on-center
Wall and fence type	Type C2

<b>4. STORY HEIGHT</b>	<i>17.65.30.1.5</i>
Ground floor elevation (min/max)	n/a
<b>E</b> Ground story height (min)	10'
<b>5. TRANSPARENCY</b>	<i>17.65.30.1.6</i>
<b>F</b> Ground story (min)	20%
<b>G</b> Upper story (min)	20%
<b>H</b> Blank wall width (max)	20'
<b>6. PEDESTRIAN ACCESS</b>	<i>17.65.30.1.7</i>
<b>I</b> Street-facing entrance spacing (max)	60'
<b>7. VEHICLE ACCESS</b>	<i>17.65.30.1.8</i>
Driveway spacing (min)	50'
Distance from intersection (min)	75'
Number of lanes (max)	1
Lane width (min/max)	8'/10'

# I. Rules of Interpretation

## 1. General

### a. Street-Facing Facades

- 1) The portion of a building facade (when projected parallel to a front lot line) with no permanent structure located between the building facade and a front lot line are considered street-facing.
- 2) Building facades more than 50 feet from the maximum setback in the build-to are not included, provided they are less than 50% of the total building width.

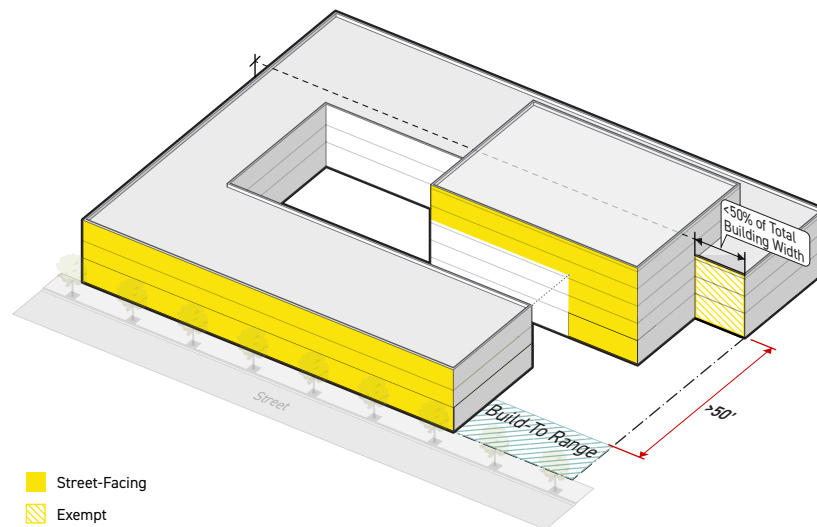

## 2. Build-To

### a. Depth

#### 1) Applicability

All new and existing lots.

#### 2) Standards

The minimum required build-to depth must be provided.

#### 3) Measurement

- a) Build-to depth is measured from the minimum front line setback.
- b) For measurement of front line setback, see *17.08.010. - Definitions (Lot Line)*.

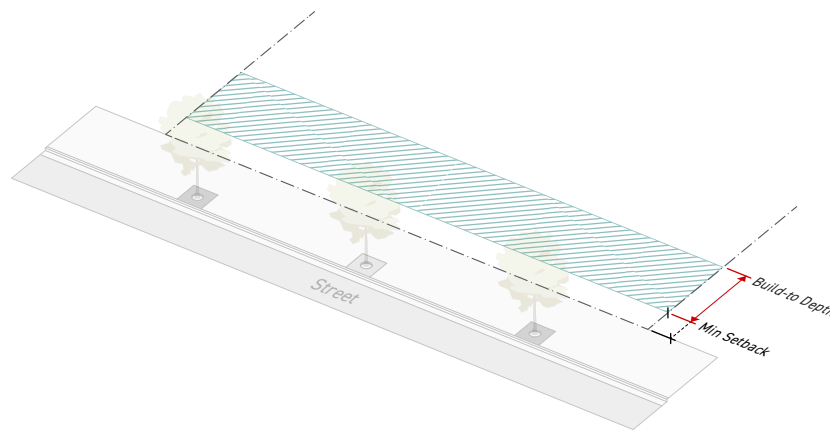

### b. Width

#### 1) Applicability

Applies in the build-to depth.

#### 2) Standards

- a) A building must be located within the build-to depth for at least the minimum required build-to width for a height equal to the minimum required building height. If there is no minimum building height, build-to depth applies to the ground story only.
- b) Where no build-to width is specified in the Frontage (Secondary, Arterial, Boulevard, Local), a minimum of 75% of the total building width, measured for each buildings on the lot, must be located in the required build-to depth.

- c) On a corner lot, a building must be located within each overlapping build-to depth. At least 30 feet of building width must occupy the build-to depth along the front lot lines in both directions.

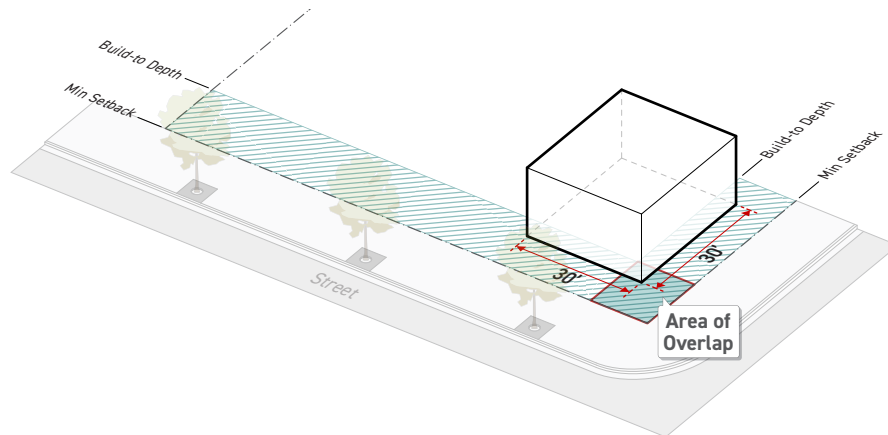

### 3) Measurement

- a) Build-to width is measured as a percentage as the sum of all building widths occupying the build-to depth, divided by the total width of the lot.

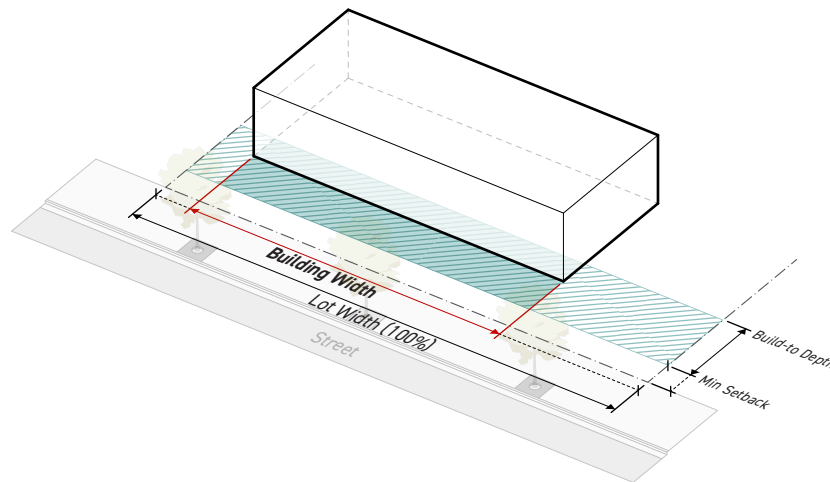

- b) The width of a vehicular entrance into or through a building does not count towards the required build-to width.

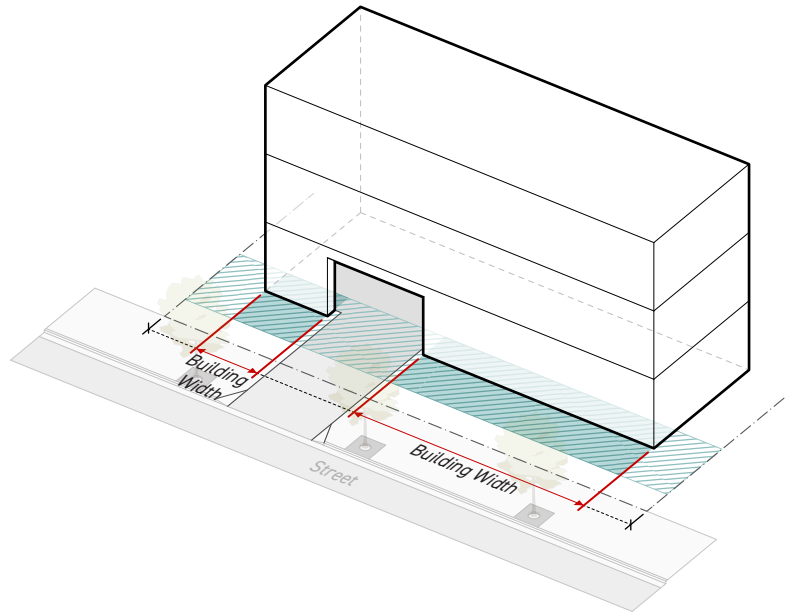

- c) For measurement of build-to depth, see 17.65.30.1.2.a.

#### 4) Exceptions

A chamfered corner no more than 20 feet in width located on the ground story of a building and extending outside of the build-to depth qualifies as building width.

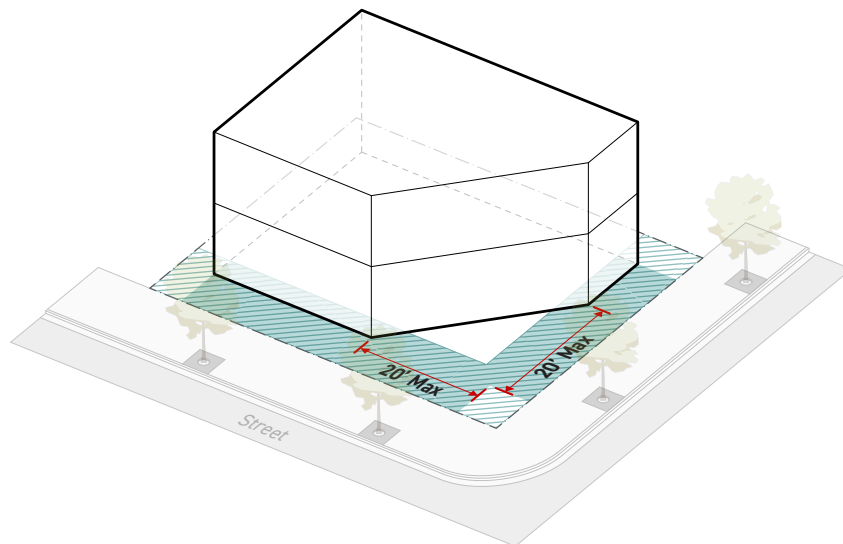

## c. Occupiable Depth

### 1) Applicability

All portions of a new building used to meet a required build-to width.

### 2) Standards

- a) The minimum required occupiable depth must be provided for a height equal to the minimum required building height. If there is no minimum building height, occupiable depth applies to the ground story only.
- b) No more than 20% of the floor area of the required occupiable depth can be used for inactive uses, such as car parking, storage, hallways, stairwells, elevators and equipment rooms.

### 3) Measurement

- a) Occupiable depth is measured from the front building facade inward to the interior of the building.

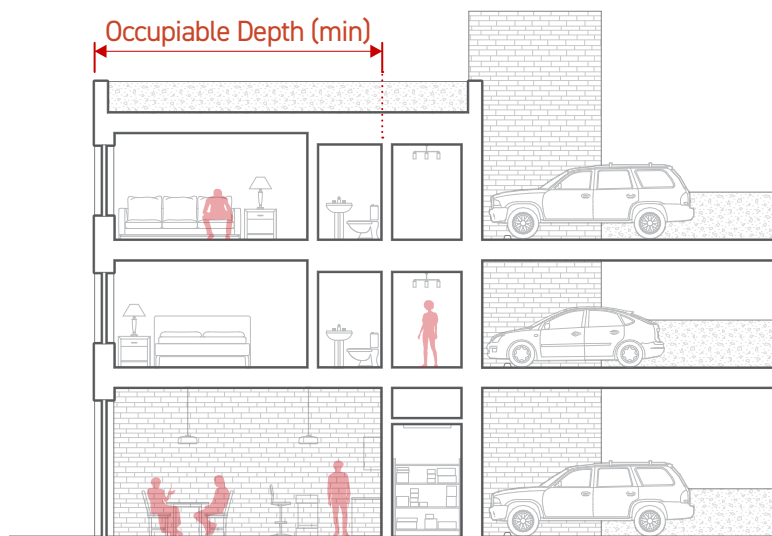

- b) For measurement of minimum building height, see 17.65.20.G.8.b.
- c) For measurement of build-to width, see 17.65.30.I.2.b.

### 3. Parking Location

#### a. No Parking Between the Building and the Street

##### 1) Applicability

All new and existing lots.

##### 2) Standards

No parking or area designed for use by a motor vehicle (for example, drive aisles, porte cocheres for drop off, loading areas) can be located between the portion of a building used to meet the required build-to width and the street.

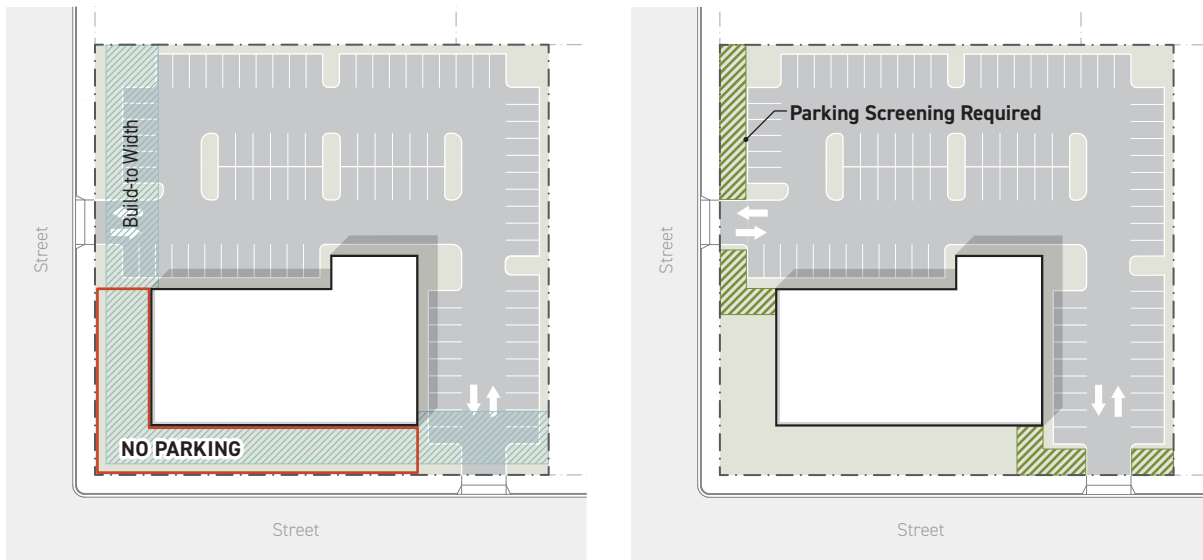

##### 3) Measurement

For measurement of build-to width, see 17.65.30.1.2.b.

#### b. Parking Screen

##### 1) Applicability

- All new and existing parking areas and other areas designed for use by a motor vehicle where no building is located between the street and the motor vehicle use area.
- The required screen must be provided along the entire perimeter where the parking or other motor vehicle area has no building located between the street and the motor vehicle use area.

##### 2) Standards

Where a Type B1 or B2 screen is required, it must meet 17.65.50.B, *Frontage Screens*.



## 4. Streetscape

### a. Applicability

All new and existing streets.

### b. Standards

#### 1) General

All new and existing streets must meet the applicable streetscape standards.

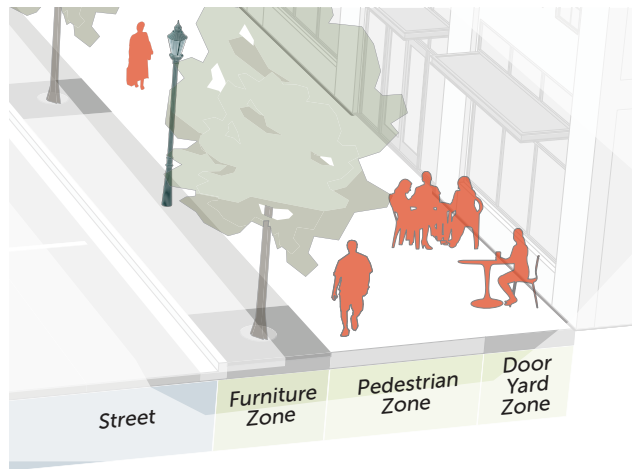

#### 2) Door Yard Zone

The door yard zone must remain clear of obstacles at all times, except the following encroachments are permitted subject to City approval.

- a) Outdoor seating areas.
- b) Outdoor display and sales areas.
- c) Benches, trash receptacles and bicycle racks.
- d) Utility boxes, meters, man hole covers, regulatory signs and fire suppression equipment.
- e) Pedestrian lighting.
- f) Landscaping, sidewalk, trees and planters.
- g) Signs.
- h) Additional elements approved by the Planning Board.

#### 3) Pedestrian Zone

The pedestrian zone must remain clear of obstacles at all times and be constructed to meet all city and ADA specifications.

#### 4) Furniture Zone

- a) One large tree must be planted every 35 feet on center, on average. Where overhead utilities exist, one small tree must be planted every 20 feet on-center, on average.
- b) Tree lawns and pits must be a minimum width of 6 feet and a minimum depth of 2 feet. Soils cannot be compacted and the surface area of the tree lawn or pit must be impervious.
- c) Tree pits must be a minimum length of 8 feet.
- d) The following encroachments are permitted in the furniture zone subject to City approval:
  - i. Benches, trash receptacles and bicycle racks.
  - ii. Utility boxes, meters, man hole covers, regulatory signs and fire suppression equipment.
  - iii. Pedestrian lighting.
  - iv. Landscaping, sidewalk, trees and planters.
  - v. Additional elements approved by the Planning Board.

#### 5) Wall and Fence Type

Where a Type C1, C2 or C3 wall or fence type is allowed, it must meet *17.65.50.H, Walls and Fences*.

#### c. Measurement

- 1) The door yard zone is excess right-of-way, primarily on existing streets, remaining after meeting the requirements of *17.65.20(G)(2), Right-of-Way*. The door yard zone is an optional area and is measured from the edge of the pedestrian zone to the front lot line.
- 2) The pedestrian zone is the area between the door yard zone or front lot line, as applicable, and the furniture zone. The pedestrian zone is measured from the edge of the furniture zone to the door yard zone or front lot line, as applicable.
- 3) Tree spacing is measured as an average to account for driveways, utilities and other potential conflicts.

### 5. Story Height

#### a. Ground Story Height

##### 1) Applicability

All new buildings for the minimum required occupiable depth.

## 2) Standards

The ground story can be no lower than the minimum required ground story height.

## 3) Measurement

- a) Ground story height is measured from the surface of the finished floor of the ground story to the surface of the finished floor of the story above. If there is no story above, ground story height is measured to the top of the ceiling structure above.

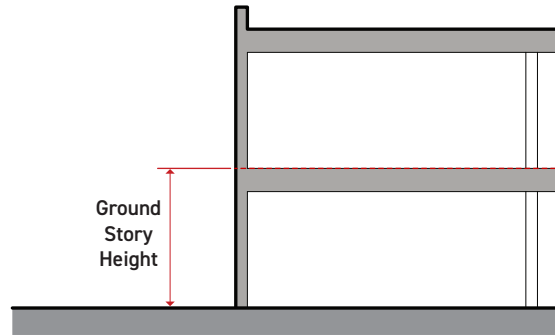

- b) For measurement of occupiable depth, see 17.65.30.1.2.c.

## b. Ground Floor Elevation

### 1) Applicability

All new buildings for the minimum required occupiable depth.

### 2) Standards

The finished floor of the ground story can be no lower than the minimum ground floor elevation and no higher than the maximum ground floor elevation.

### 3) Measurement

- a) Ground floor elevation is measured from the average sidewalk grade in front of the street-facing building facade to the top of the finished floor of the ground story.

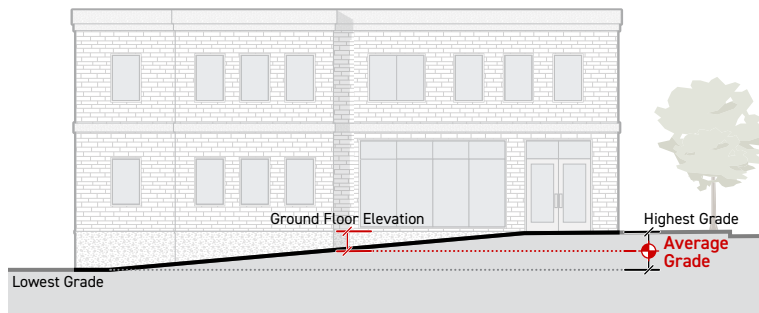

- b) Where the sidewalk is greater than 5 feet from the building, ground floor elevation is measured from the lowest elevation of finished grade within 5 feet of the building perimeter, measured from and perpendicular to the top of the finished floor.
- c) For measurement of occupiable depth, see 17.65.30.1.2.c.

## 6. Transparency

### a. Ground and Upper Story Transparency

#### 1) Applicability

All new street-facing building facades, see 17.65.30.1.1.a.

#### 2) Standards

- a) All applicable ground and upper stories must provide the minimum amount of required transparency.
- b) Interior walls and other interior visual obstructions cannot be located within 5 feet of any facade area counting towards a ground floor transparency requirement.



#### 3) Measurement

##### a) General

- i. Transparency is measured as a percentage of the sum of all facade area meeting the measurement requirements for transparency, divided by the total applicable facade area.
- ii. Transparent windows and doors, along with components such as trim and mullions that are integral to window and door assemblies that are less than 5 inches in width, may be included in the calculation of transparent area.

## b) Ground Story

- i. For the purpose of calculating ground story transparency, ground story facade area is measured as the portion of a facade between 2 and 12 feet above the finished floor of the ground story. No portion of a ground story facade area located below finished grade is included in ground story facade area.



- ii. If the ground story height is less than 12 feet, the ground story facade area is measured as the total above-grade portion of a facade between the top of the finished floor of the ground story and the top of the finished floor above. When there is no story above, ground story height is measured to the top of the wall plate.
- iii. For residential portions of a story, glass is considered transparent where it has a visual transmittance of 30% or higher and an external reflectance of less than 40%.
- iv. For nonresidential portions of a story, glass is considered transparent where it has a visual transmittance of 60% or higher and an external reflectance of less than 20%.

### c) Upper Stories

- i. For the purpose of calculating upper story transparency, upper story facade area is measured as the portion of a facade area between the top of the finished floor for that story to the top of the finished floor above. When there is no story above, it is measured to the top of the wall plate.
- ii. Upper story transparency is measured separately for each individual story of a building facade above the ground story.
- iii. For upper stories, glass is considered transparent where it has a visual transmittance of 30% or higher and an external reflectance of less than 40%.



### b. Blank Wall Width

#### 1) Applicability

- a) Portions of new street-facing building facades (see 17.65.30.1.1.a) between 3 feet and 8 feet from the finished ground floor elevation.

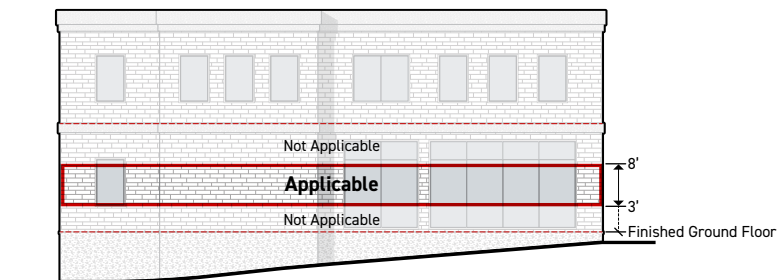

- b) All portions of new street-facing building foundation walls that are exposed more than 4 feet in height above the surrounding sidewalk surface. If foundation walls are set back more than 10 feet from a sidewalk, exposed height is measured from the lowest elevation of finished grade within 5 feet, measured from and perpendicular to the foundation wall.

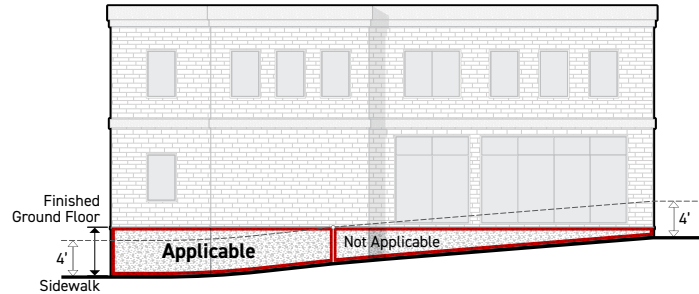

## 2) Standards

### a) Blank Ground Story Wall

Window and door openings meeting 17.65.30.1.6.a. (*Ground and Upper Story Transparency*) on applicable ground story facades can be separated by a distance no more than the maximum blank wall width unless a blank ground story wall treatment of 17.65.30.1.6.b.4.b) is applied.

### b) Blank Foundation Wall

Applicable portions of foundation walls can be no wider than the maximum blank wall width unless a blank ground story wall treatment of 17.65.30.1.6.b.4.c) is applied.

## 3) Measurement

### a) Blank Ground Story Wall

Blank wall width is measured horizontally and parallel to the front lot line from the edge of one window or door to the edge of the other window or door or to the edge of the ground floor facade.

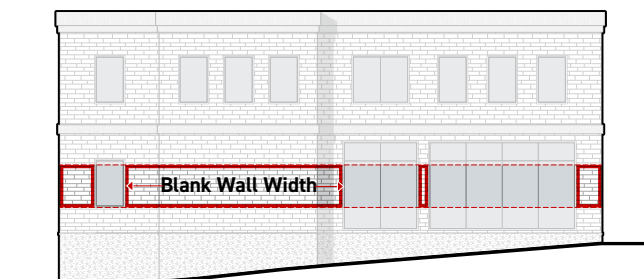

## b) Blank Foundation Wall

Blank wall width is measured horizontally for any individual width of applicable foundation wall that does not include required transparency, see *17.65.30.1.6.a. (Ground and Upper Story Transparency)*.

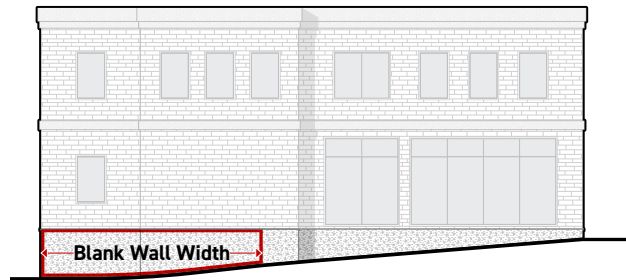

## 4) Blank Wall Treatments

### a) General

- i. Ground story facades that exceed the maximum allowed blank wall width may apply one or more ground story blank wall treatment to the blank wall and double the allowed blank wall width.
- ii. Foundation walls that exceed the maximum allowed blank wall width may apply one or more blank foundation wall treatment to the blank foundation wall and double the allowed blank wall width.
- iii. All trees and shrubs provided to meet the blank wall treatment must meet *17.65.50.1, Plant Material*.



## b) Ground Story Blank Wall Treatments

### Trees

Trees planted between the blank wall and the sidewalk.

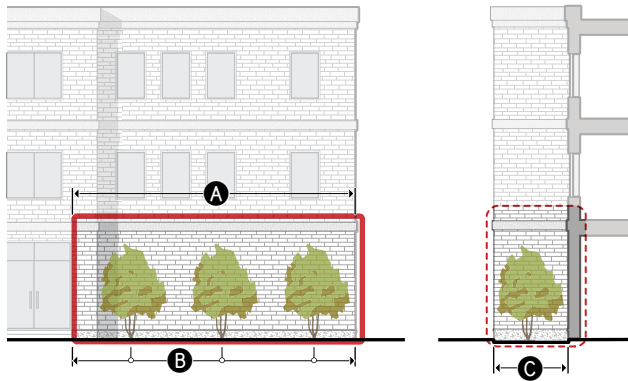

TREE STANDARDS	
Ⓐ Treatment width (min portion of blank wall)	100%
Tree type	Small
Ⓑ Planting frequency (min avg.)	5 per 100'
Ⓒ Planting area depth (min)	7'

### Living Wall

A permanently fixed assembly located between the blank wall and the sidewalk that supports plants, their growing medium and irrigation.

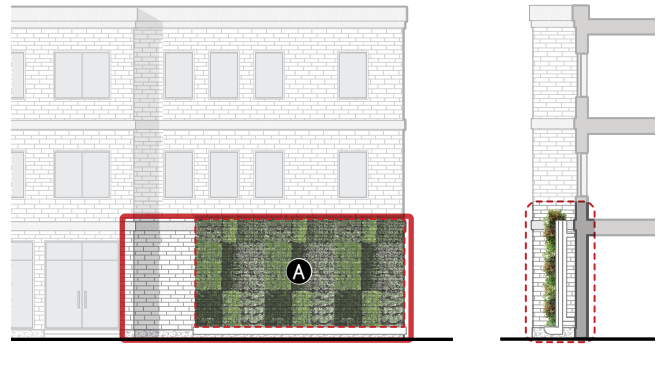

LIVING WALL STANDARDS	
Ⓐ Treatment area (min % of ground story facade with blank walls)	75%

## c) Foundation Blank Wall Treatments

### Foundation Planting

Landscape planted along the blank foundation wall.

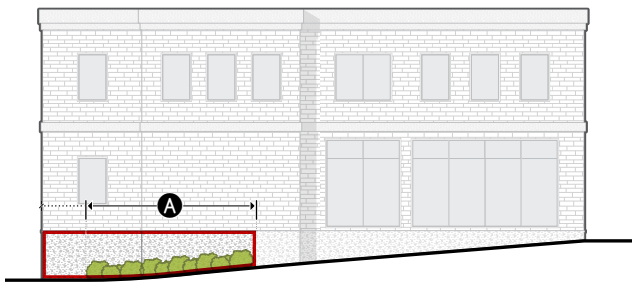

#### FOUNDATION PLANTING STANDARDS

<b>A</b>	Treatment width (min portion of blank wall)	75%
<b>B</b>	Plant type	Screening plant
	Planting frequency (min avg.)	3 per 100'
<b>C</b>	Planting area depth (min)	3'

### Pedestrian Access

A permanently fixed assembly located between the blank wall and the sidewalk that supports plants, their growing medium and irrigation.

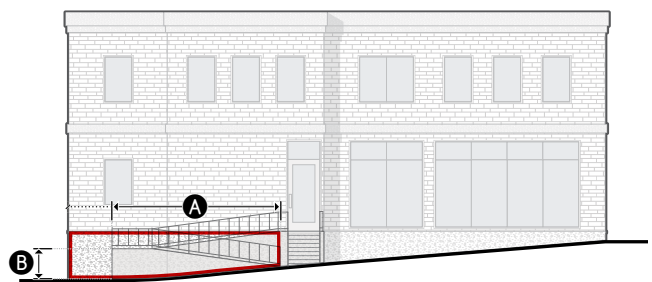

#### PEDESTRIAN ACCESS STANDARDS

<b>A</b>	Treatment area (min % of ground story facade with blank walls)	75%
<b>B</b>	Height above sidewalk (max)	4'

#### **d) Blank Wall Treatment Measurements**

i. Treatment Width

Minimum treatment width is measured as a percentage, calculated as the cumulative width of blank wall treatments applied to a blank wall divided by the total width of the blank wall.

ii. Treatment Area

Minimum treatment area is measured as a percentage, calculated as the cumulative area of blank wall treatments applied to a blank wall divided by the total area of the blank wall.

iii. Planting Frequency

Planting frequency is measured as a ratio of the minimum number of plants required over a specified width of treated blank wall. A minimum of one plant of the required plant type must be provided regardless of the width of blank wall treatment.

iv. Planting Area Depth

Minimum planting area depth is measured as the horizontal dimension of growing medium at the narrowest point, measured perpendicular to the applicable street lot line. The planting area must be open to the sky for at least the required planting area depth.

v. Height Above Sidewalk

A). Height above sidewalk is measured vertically from the surrounding sidewalk surface to the topmost point of the blank wall treatment along the entire treated portion of a blank foundation wall.

B). For foundation walls located more than 10 feet from a sidewalk, maximum height above sidewalk is measured from the lowest elevation of finished grade within 5 feet, measured from and perpendicular to the foundation wall, to the topmost point of the blank wall treatment along the entire treated portion of a blank foundation wall.

## 7. Pedestrian Access

### a. Street-Facing Entrances

#### 1) Applicability

All new street-facing building facades, see 17.65.30.1.1.a.

#### 2) Standards

##### a) General

A required street-facing entrance must meet the following standards.

- i. Be located on a ground story facade.
- ii. Provide both ingress and egress pedestrian access to the ground story of the building.
- iii. Must access an occupiable space.
- iv. Remain operable at all times. Access may be controlled and limited to residents or tenants.
- v. Non-required entrances are allowed in addition to required entrances.

##### b) Entrance Spacing

Required street-facing entrances cannot be located farther apart than the maximum entrance spacing requirement.

### c) Entrance Design

- i. A required street-facing entrance must face and be directly accessible from the public right-of-way along the front lot line.
- ii. Each required street-facing entrance must be designed to meet one of the following sets of requirements.
- iii. An entrance directly accessed from one of the design options counts as a street-facing entrance, regardless if it faces the street.

#### Porch

A wide, raised platform, projecting in front of a street-facing entrance, that is entirely covered but not enclosed.

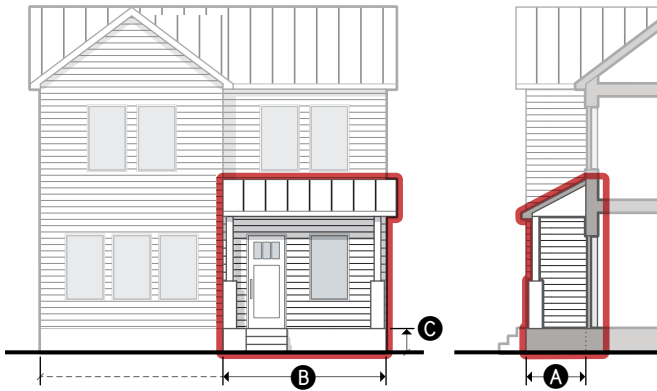

##### PORCH STANDARDS

<b>A</b> Depth (min)	4.5'
<b>B</b> Width (min)	30%
Covered entrance	n/a
Covered area (min)	100%
<b>C</b> Finished floor elevation (min/max)	2'/5'
Enclosure (max)	50%

Encroachments into the public right-of-way are subject to approval of a license.

#### Raised Entry

A raised platform accessed from an exterior staircase, providing covered access to a street-facing entrance.

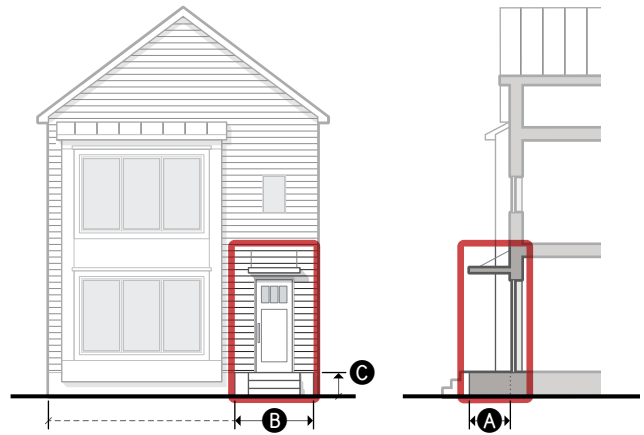

##### RAISED ENTRY STANDARDS

<b>A</b> Depth (min)	3'
<b>B</b> Width (min)	4'
Covered entrance	Required
Covered area (min)	n/a
<b>C</b> Finished floor elevation (min/max)	2'/5'
Enclosure (max)	50%

Encroachments into the public right-of-way are subject to approval of a license.

## Recessed Entry

A space set behind the primary facade plane providing sheltered access to a street-facing entrance.

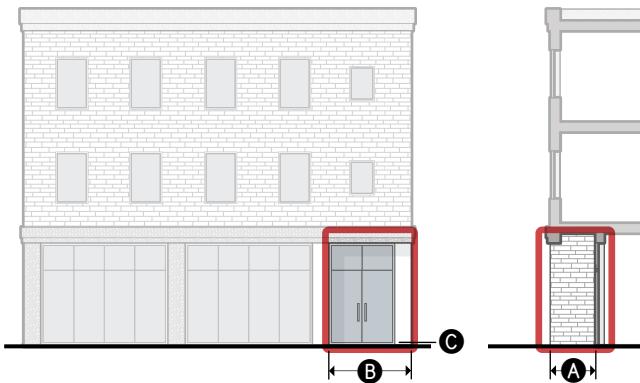

RECESSED ENTRY STANDARDS	
<b>A</b> Depth (min/max)	3'/15'
<b>B</b> Width (min)	5'
Covered entrance	n/a
Covered area (min)	100%
<b>C</b> Finished floor elevation (min/max)	-2'/5'
Enclosure (max)	75%

## Covered Entry

A space that provides sheltered access to an at-grade street-facing entrance with an overhead projecting structure.

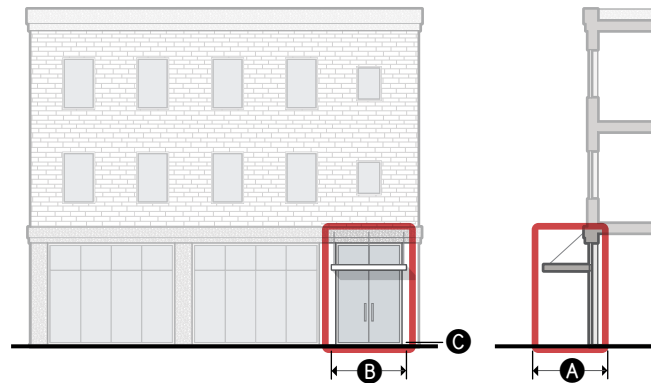

COVERED ENTRY STANDARDS	
<b>A</b> Depth (min)	n/a
<b>B</b> Width (min)	n/a
Covered entrance	Required
Covered area (min)	n/a
<b>C</b> Finished floor elevation (min/max)	-2'/2'
Enclosure (max)	50%

Encroachments into the public right-of-way are subject to approval of a license.

## Forecourt

A yard screened with a short wall, fence or hedge that provides significant privacy for ground story tenants located near sidewalk grade.



### FORECOURT STANDARDS

<b>A</b> Depth (min)	8'
<b>B</b> Width (min)	10'
Covered entrance	Required
Covered area (min)	n/a
<b>C</b> Finished floor elevation (min/max)	-2'/5'
Privacy wall height (min/max)	3'/4'

### 3) Measurement

#### a) Spacing

- i. Entry spacing is measured as the horizontal distance from edge of door to edge of door and edge of door to edge of building.
- ii. The entry spacing requirements must be met for each building and abutting buildings within a project, but are not applicable to buildings unrelated to the project.

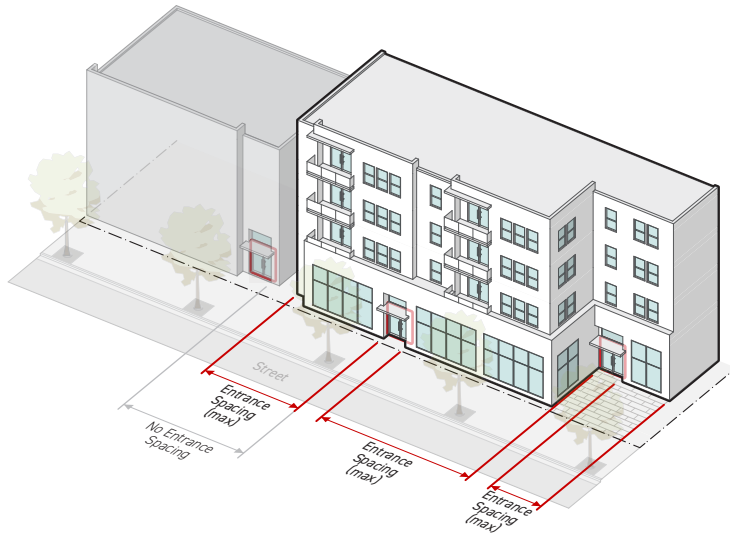

#### b) Applicability

Standards apply only to the occupiable space of the entry. Stairs and ramps used for are not considered occupiable area for the purpose of meeting the standards.

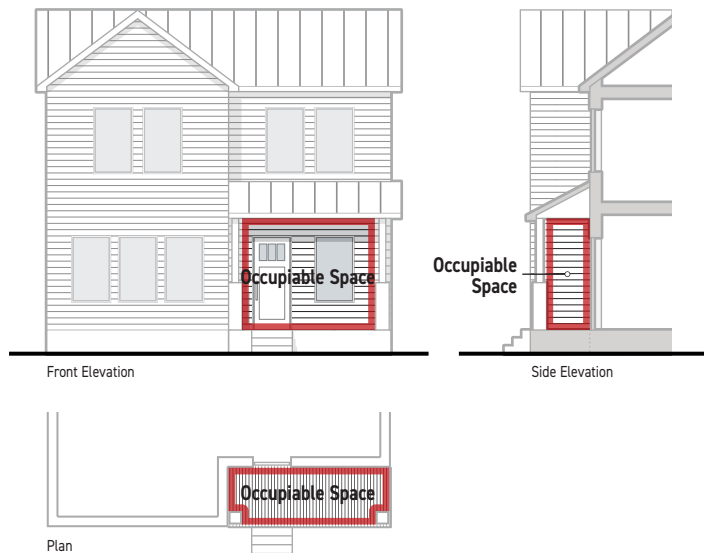



**c) Depth**

Minimum depth is measured as the horizontal dimension at the narrowest point of an entry feature, measured perpendicular to the front lot line.

**d) Width**

- i. When specified in feet, minimum width is measured as the total width of an entry feature, measured parallel to the front lot line.
- ii. When specified as a percentage, minimum width is measured as the total width of the entry feature divided by the total length of the building facade that the entry is located on, measured parallel to the front lot line.

**e) Covered Entrance**

- i. A canopy, roof or other sheltering structure must cover the exterior area immediately abutting the associated street-facing entrance.
- ii. The minimum depth of the covered entrance must be the clear height of the covered area divided by 3.
- iii. The minimum width of the covered entrance must be the clear height of the covered area divided by 2.

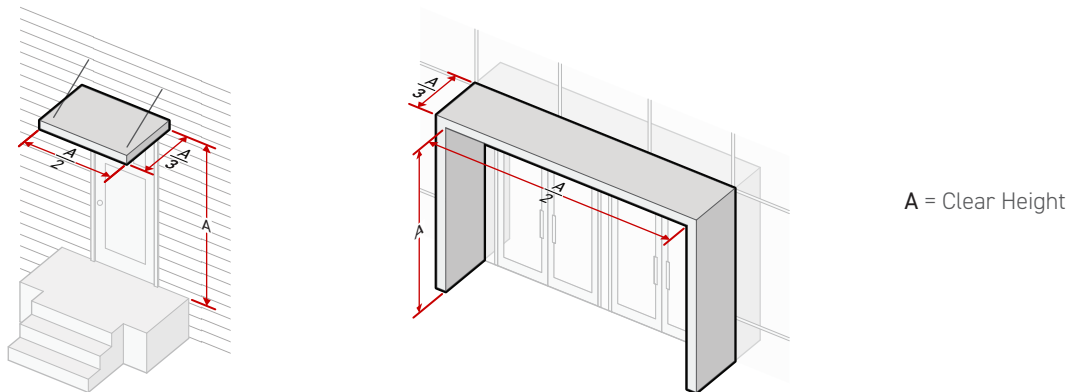

**f) Covered Area**

The percentage of the entry feature area that must be covered by a canopy, roof or other sheltering structure, measured as the total covered area of the entry feature divided by the total area of the entry.

**g) Finished Floor Elevation**

Finished floor elevation is measured from the adjacent sidewalk grade to the top of the finished floor surface or ground surface of the entry along the entire width.

**h) Enclosure**

- i. Enclosure is measured as a percentage calculated by measuring the linear distance around the occupiable space of the entry feature at a height of 4 feet and dividing the enclosed portions of the perimeter length by the total perimeter length.

- ii. Any wall or barrier of 4 feet or less in height is not included in the calculation of enclosure.

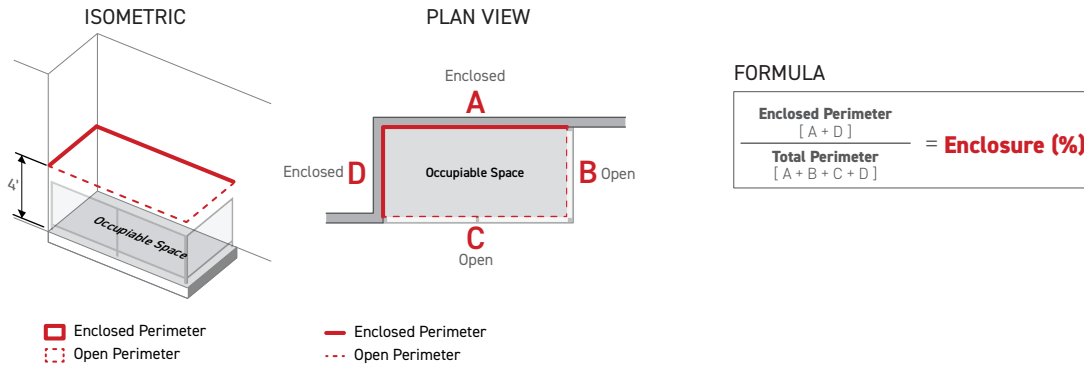

### i) Privacy Walls

- i. Privacy walls must fully enclose the perimeter of a private forecourt with the exception of a gate no more than 5 feet wide
- ii. Privacy wall height is measured from finished grade to the topmost point of the privacy wall structure along the perimeter of the forecourt.

## 8. Vehicle Access

### a. Driveway Spacing

#### 1) Applicability

Applies to all driveways.

#### 2) Standards

- a) No driveway may be located closer to any other driveway than the minimum driveway spacing required.
- b) Where this standard effectively prohibits access to a site, the Planning Board may approve an alternate driveway location that minimizes conflicts with pedestrians, bicyclists and other vehicles to the greatest extent feasible.

### 3) Measurement

Driveway spacing is measured along the front lot line from edge of pavement to edge of pavement from all existing and proposed driveways located on-site and on adjacent lots.

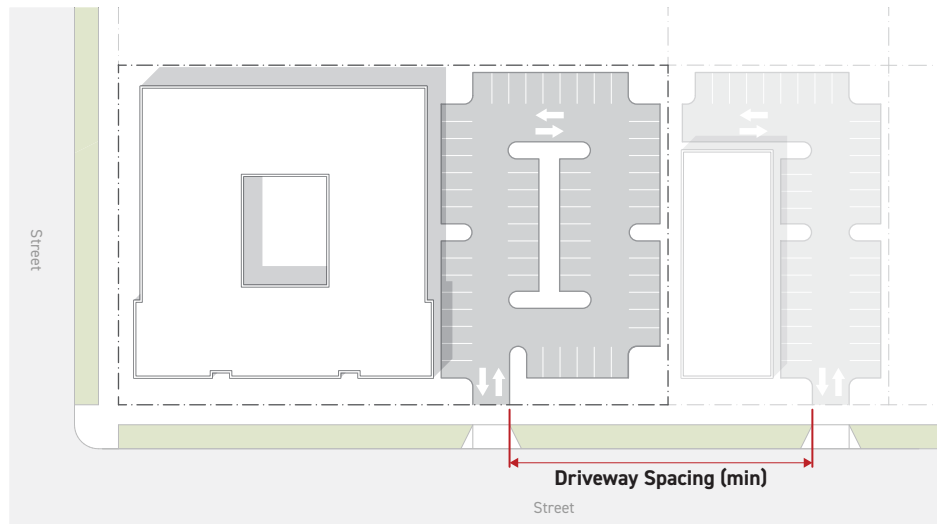

## b. Number of Driveways

### 1) Applicability

Applies to all driveways.

### 2) Standards

- a) The total number of driveways accessing a site along a front lot line cannot exceed the maximum number of driveways allowed.
- b) Where no driveways are allowed, no driveway is allowed along the front lot line.
- c) No driveway is allowed anywhere along a block face where more than 40% of the block face is designated with a Frontage doesn't allow driveways.

### 3) Measurement

- a) Number of driveways are measured as the cumulative number of driveways providing access through any front lot line on an individual block face.
- b) A driveway having contiguous vehicular access lanes counts as a single driveway regardless of the number of lanes.
- c) Driveways having median between lanes designated for opposite directions counts as a single driveway.

## c. Distance From Intersection

### 1) Applicability

Applies to all driveways that specify a distance before intersection, distance after intersection or distance from intersection standard.

## 2) Standards

### a) General

Where a minimum distance from an intersection standard effectively prohibits access to a lot, the Planning Board may approve an alternative driveway location that minimizes conflicts with pedestrians, bicyclists and other vehicles to the greatest extent feasible.

### b) Distance From Intersection

Where a Frontage specifies a minimum distance from intersection, no driveways are allowed to be located closer to any street intersection than the minimum distance specified.

### c) Distance After Intersection

Where a Frontage specifies a minimum distance after intersection, no driveways are allowed to be located closer to an upstream street intersection than the minimum distance specified.

### d) Distance Before Intersection

Where a Frontage specifies a minimum distance before intersection, no driveways are allowed to be located closer to a downstream street intersection than the minimum distance specified.

## 3) Measurement

- a) Distance from upstream intersection is measured from the edge of pavement of the driveway nearest an upstream intersection, parallel to the frontage lot line and in the opposite direction as the flow of traffic in the nearest street travel lane, to the nearest intersection. For the purpose of measuring distance from intersections, nearest intersections is the intersection of two block faces.
- b) Distance from downstream intersection is measured from the edge of pavement of the driveway nearest a downstream intersection, parallel to the frontage lot line and in the same direction as the flow of traffic in the nearest street travel lane, to the nearest intersection. For the purpose of measuring distance from intersections, nearest intersections is the intersection of two block faces.
- c) Distance to intersection is measured for both upstream and downstream intersections.

## d. Number of Lanes

### 1) Applicability

Applies to all driveways.

### 2) Standards

#### a) General

- i. No driveway can include more lanes than the maximum number of lanes.

- ii. Driveways having median between travel lanes counts as a single driveway. The median does not count as a driveway lane.
- iii. Where additional driveway lanes are necessary to accommodate the anticipated traffic, the Planning Board may approve driveway configurations that include 1 travel lane in excess of the maximum number of lanes specified, provided that the driveway design minimizes conflicts with pedestrians, bicyclists and other vehicles to the greatest extent feasible.

**b) Lane Width**

No travel lane within a driveway can have a width greater than the maximum lane width allowed.

**3) Measurement**

**a) Number of Lanes**

Number of lanes is measured as all lanes within a driveway, including each lane designated for different directions travel, lanes designated for turning movements and any other area designed and designated for motor vehicle use between a parking facility and the public right-of-way.

**b) Lane Width**

- i. Lane width is measured separately for each driveway lane.
- ii. Lane width is measured at the widest point of each driveway lane from edge of designated lane to edge of designated lane measured parallel to the frontage lot line.

**e. Throat Depth**

**1) Applicability**

Applies to all driveways where.

**2) Standards**

Drive lane intersections, access to parking spaces, garage access lanes, loading areas or any other site elements that either serves as a destination for motor vehicles or allows turning movements by motor vehicles are prohibited within the minimum throat depth specified.

**3) Measurement**

Throat depth is measured from the face of curb along the street, to the nearest intersecting drive lane, parking space, garage access lane, loading area and any other motor vehicle destination or turning movement.

# 17.65.40. **PARKING AND LOADING**

## A. **Applicability**

### 1. **New Construction**

Any new building or site improvement must meet the following parking and loading requirements.

### 2. **Additions**

- a. When an existing building, use or site is increased in gross square footage, or improved site area, by up to 25% cumulatively, the following parking and loading requirements apply to the additional area only.
- b. When an existing building, use or site is increased in gross square footage, or improved site area, by more than 25% cumulatively, both the existing building, use or site, and the additional area, must meet the following parking and loading requirements.

### 3. **Ordinary Maintenance and Repair**

Work involving ordinary maintenance and repair may be undertaken without meeting the following parking and loading requirements, provided there is no increase in gross square footage or improved site area.

### 4. **Change in Use**

A change in use only has to meet *17.65.40.B, Bicycle Parking*.

## B. Bicycle Parking

### 1. Required Bicycle Parking Spaces

Bicycle parking must be provided in accordance with the following table.

	Required Short-Term Spaces (min)	Required Long-Term Spaces (min)
<b>RESIDENTIAL USES</b>		
Multi-family, Live-work	1/20 units, min 3	1/5 units (projects with 10+ units only)
All other residential uses	None	None
<b>PUBLIC/CIVIC USES</b>		
All uses	1/10,000 SF of gross square footage, 2 min	1/5,000 SF of gross square footage, 2 min
<b>COMMERCIAL USES</b>		
All uses	1/5,000 SF of gross square footage, 2 min	1/5,000 SF of gross square footage, 2 min
<b>EMPLOYMENT USES</b>		
All uses	1/10,000 SF of gross square footage, 2 min	1/5,000 SF gross square footage, 2 min
<b>MARINE USES</b>		
All uses	1/10,000 SF of gross square footage, 2 min	1/10,000 SF of gross square footage, 2 min
<b>INDUSTRIAL USES</b>		
All uses	1 per 10,000 SF of gross square footage, 2 min	1/10,000 SF of gross square footage, 2 min

### 2. Bicycle Facilities

#### a. General

- 1) Bicycle parking must consist of bicycle racks that support the bicycle frame at two points.
- 2) Racks must allow for the bicycle frame and at least one wheel to be locked to the rack.
- 3) If bicycles can be locked to each side of the rack, each side can be counted toward a required space.
- 4) Spacing of bicycle racks must provide clear and maneuverable access.
- 5) Racks must be securely anchored to a permanent surface.
- 6) Bicycle parking spaces must be a minimum of 2 feet wide and 6 feet long.
- 7) Bicycle parking must be provided in a well-lit area.

## **b. Short-Term Bicycle Parking**

- 1) Required short-term bicycle spaces must be publicly accessible and be located no more than 100 feet from the building entrance the bicycle space is intended to serve.
- 2) Short-term bicycle parking spaces may be located within the public right-of-way subject to approval of a license for use of public right-of-way.
- 3) Business operators or property owners who choose to install bicycle parking within the public right-of-way are responsible for maintaining the racks.

## **c. Long-Term Bicycle Parking**

- 1) Required long-term bicycle spaces must be located no more than 200 feet from the building entrance the bicycle space is intended to serve.
- 2) Long-term bicycle spaces must be located in an enclosed and secured or supervised area providing protection from theft, vandalism and weather, and must be accessible to intended bike users. Acceptable examples of long-term bicycle parking include bicycle lockers, bicycle rooms, bicycle cages or in parking structures.
- 3) Required long-term bicycle spaces for residential uses cannot be located within dwelling units or within deck, patio areas or private storage areas accessory to dwelling units.

# **C. Automobile Parking**

## **1. Parking Space Standards**

- a. The automobile parking requirements of *17.104.020* do not apply. No minimum parking is required.
- b. The number of off-street parking spaces provided cannot exceed the number of spaces required by *17.104.020*, unless provided in a parking structure.

## **2. Reserved Parking**

- a. If parking is provided, parking spaces may be reserved for a specific tenant or unit, provided that the following standards are not exceeded.

### **1) Residential**

- a) One space per efficiency or 1-bedroom multi-family dwelling unit or live-work unit.
- b) Two spaces per 2-bedroom or greater multi-family dwelling unit or live-work unit.
- c) There is no limit for all other allowed residential uses.

### **2) Nonresidential**

No more than 25% of the total nonresidential parking spaces provided may be reserved for a specific use or set of uses.



### 3. **Parking Space Design Standards**

The requirements of *17.104.040* do not apply, except for *17.104.040.C*.

### 4. **Parking Spaces and Parking Lot Construction Standards**

#### **a. Applicability**

- 1) The requirements of *17.104.050* do not apply.
- 2) The following parking space and parking lot construction standards apply to all surface parking areas not within a parking structure.

#### **b. Design**

- 1) All portions of a parking area must be accessible by automobiles to all other portions of a parking area without requiring the use of a street.
- 2) Each parking space must be located so that no automobile is required to back onto any street or sidewalk to leave the parking space.
- 3) Full and permanent parking space delineation is required. Delineation may include striping, wheel stops, landscaping, timber, curbing, or other similar permanent materials which can clearly define and delineate space. Full parking space delineation means clear markings for all three sides of the space.

#### **c. Surfacing**

- 1) All parking areas must be graded and drained to collect, retain and infiltrate surface water on-site by applying low impact development practices and standards in accordance with the North End Urban Plan.
- 2) All parking areas must be provided with an all-weather surface. The all-weather surfaces may consist of asphalt or concrete. Alternative materials such as crushed stone, shells, porous pavers, or other porous materials may be allowed if it can be demonstrated that such materials will be properly maintained. Proper maintenance includes ensuring that such materials are kept and regularly scheduled maintenance is provided to retain parking lot functionality.

#### **d. Interior Landscaping**

##### **1) General**

- a) The required length of parking spaces may overhang the planting area by up to 2 feet.
- b) All plants must meet *17.65.50.I, Plant Material*.

## 2) Interior Islands

- a) A interior island must be provided every 10 parking spaces and at the end of every parking row. Intervals may only be modified in order to preserve existing trees. Interior islands must be distributed evenly throughout the parking area.
- b) An interior island abutting a single row of parking spaces must be a minimum of 13.5 feet in width and 200 square feet in area. This island must include 1 large tree.
- c) An interior island abutting a double row of parking spaces must be a minimum of 13.5 feet in width and 400 square feet in area. This island must include 2 large trees.

## 3) Median Islands

- a) A median island must be provided between every 4 single rows of parking. Intervals may only be modified in order to preserve existing trees.
- b) The median island must be a minimum of 6 feet wide. A median island with a pedestrian walkway must be a minimum of 12 feet wide.

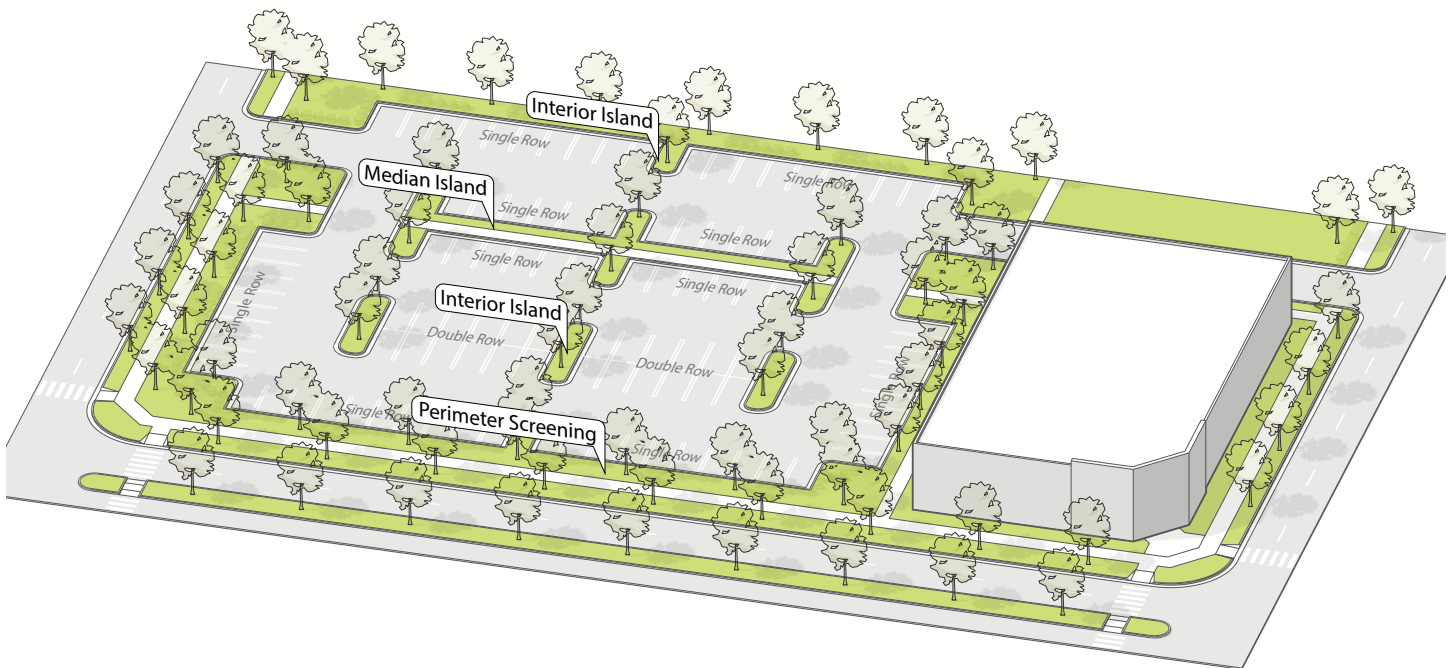

### e. Perimeter Screening

A Type B1 or B2 frontage screen (17.65.50.B) is required for parking lots. The frontage standards indicate which frontage screen types are required - see 17.65.30, *Frontages*.

## D. Loading

### 1. Applicability

If determined necessary by the Planning Board, adequate space must be made available on-site for the unloading and loading of goods, materials, items or stock for delivery and shipping, otherwise the on-site loading requirements of *17.104.030* do not apply.

### 2. Location

If a loading area is provided, it must meet the following.

- a. With the exception of areas specifically designated by the City, loading and unloading activities are not permitted on a street, not including an alley.
- b. Loading and unloading activities may not encroach on or interfere with the use of sidewalks, drive aisles, queuing areas or parking areas.
- c. Loading areas must be located to the rear or side of buildings.
- d. Loading areas cannot be placed between a street (not including an alley) and the building. A Type B3 frontage screen (*17.65.50.B*) is required along the front lot line where a loading area faces a front lot line.

# 17.65.50. LANDSCAPE AND SCREENING

## A. Applicability

### 1. New Construction

Any new building or site improvement must meet the following landscape and screening requirements.

### 2. Additions

- a. When an existing building, use or site is increased in gross square footage, or improved site area, by up to 25% cumulatively, the following landscape and screening requirements apply to the additional area only.
- b. When an existing building, use or site is increased in gross square footage, or improved site area, by more than 25% cumulatively, both the existing building, use or site, and the additional area, must meet the following landscape and screening requirements.

### 3. Ordinary Maintenance and Repair

Work involving ordinary maintenance and repair may be undertaken without meeting the following landscape and screening requirements, provided there is no increase in gross square footage or improved site area.

### 4. Change in Use

A change in use does not have to meet the following landscape and screening requirements.

## B. Frontage Screens

### 1. Applicability

Frontage screen standards are applicable when required by *17.65.30, Frontages* or *17.65.40, Parking and Loading*.

### 2. General

- a. Required frontage screens must be located along the front lot line for the perimeter of the use subject to screening requirements.
- b. Breaks for pedestrian, bicycle and vehicular access are allowed, provided the break in the screen is the minimum practical width. Driveways or walkways must cross at or near a perpendicular angle.
- c. No buildings, structures or areas designed for motor vehicles are allowed in the required screening area, except for a fence or wall.
- d. All wall and fences must meet *17.65.30.H.3, Wall/Fence Design and Installation*.
- e. All plants must meet *17.65.50.I, Plant Material*.

### 3. Frontage Screen Standards

#### Type B1

Intended for screening parking areas including drive aisles, maneuvering areas and fire lanes that face a front lot line.

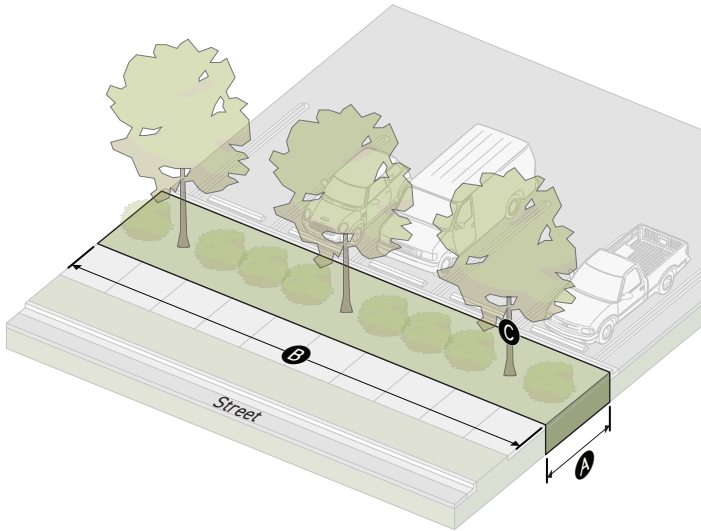

PLANTING AREA	
<b>A</b> Depth (min)	10'
<b>B</b> % of perimeter screened (min)	80%
Required plant type	Screening plants
<b>C</b> Large trees (min per 50')	3
WALLS & FENCES	
Height	n/a
Opacity	n/a

#### Type B2

Intended for screening parking areas including drive aisles, maneuvering areas and fire lanes that face a front lot line.

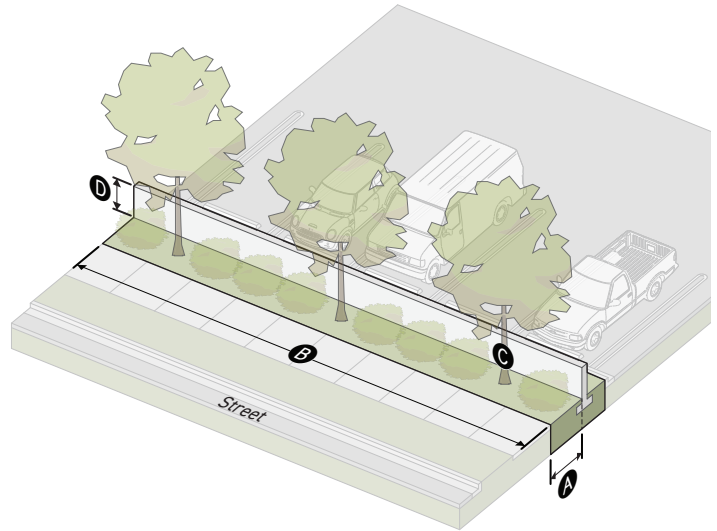

PLANTING AREA	
<b>A</b> Depth (min)	5'
<b>B</b> % of perimeter screened (min)	80%
Required plant type	Screening plants
<b>C</b> Large trees (min per 50')	3
WALLS & FENCES	
<b>D</b> Height (min)	3.5'
Opacity	
Below 3.5' (min)	90%
3.5' and above (max)	50%

## Type B3

Intended for screening outdoor areas associated with moderate-impact uses such as loading areas that face a front lot line.

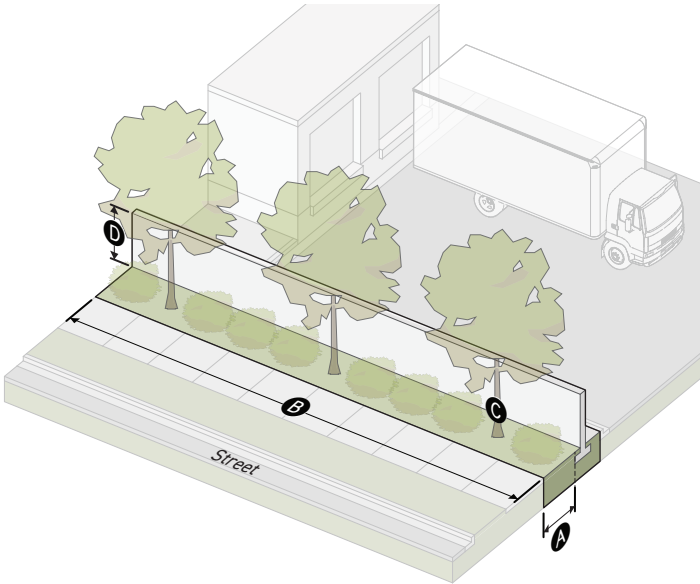

PLANTING AREA	
A Depth (min)	5'
B % of perimeter screened (min)	80%
Required plant type	Screening plants
C Large trees (min per 50')	3
WALLS & FENCES	
D Height (min)	6'
Opacity (min)	90%

## Type B4

Intended for screening outdoor areas associated with high-impact uses such as outdoor storage that face a front lot line.

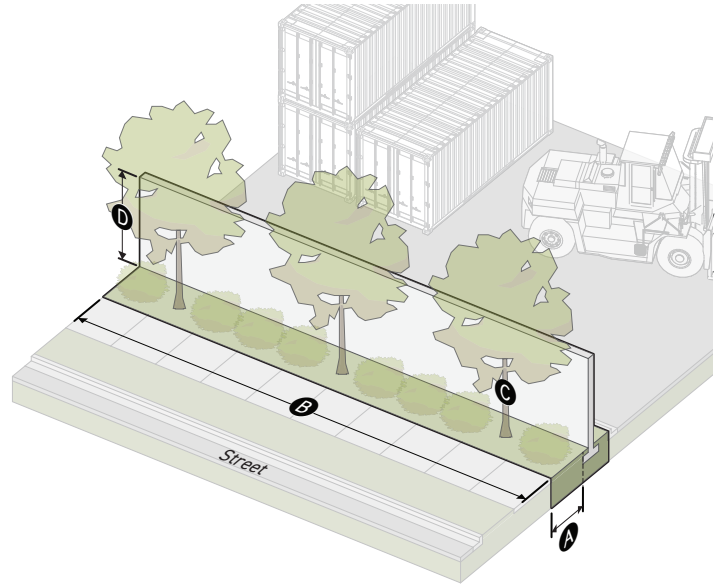

PLANTING AREA	
A Depth (min)	5'
B % of perimeter screened (min)	80%
Required plant type	Screening plants
C Large trees (min per 50')	3
WALLS & FENCES	
D Height (min)	10'
Opacity (min)	90%

## C. Waste Receptacle Screening

### 1. Location

Outdoor waste receptacles and their screening enclosures must be located to the side and rear of buildings.

### 2. Screening Enclosure

- Outdoor waste receptacles must be screened on three sides by a solid wall or fence a minimum height of 6 feet.
- Access gates must be provided on the fourth side and must also be a minimum height of 6 feet.
- The screening enclosure must meet *17.65.50.H.3, Wall/Fence Design and Installation*.

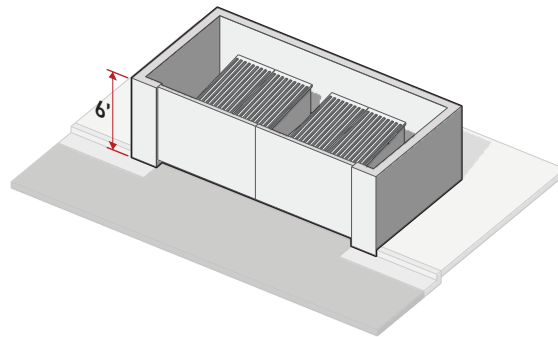

## D. Roof-Mounted Equipment Screening

### 1. Applicability

All mechanical or utility equipment located on a roof must meet the following screening standards.

### 2. Standards

- Equipment must be screened on the roof edge side by a solid parapet wall or other type of solid screen that is at least height 6 inches higher than the topmost point of the equipment being screened.
- Any screening used must meet *17.65.30.H.3, Wall/Fence Design and Installation*.

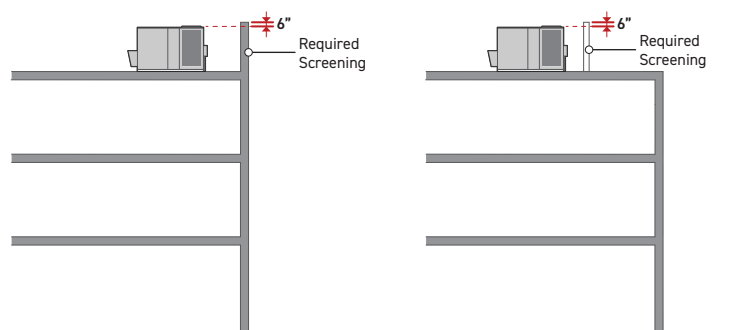

## E. Ground-Mounted Equipment Screening

### 1. Applicability

All ground mounted outdoor mechanical or utility equipment must meet the following screening standards.

### 2. Standards

#### a. Location

Ground mounted equipment cannot be located in front of buildings unless it is screened meeting the standards below.

#### b. Screening Enclosure

- 1) Equipment must be screened on three sides by a solid wall or fence that is at least height 6 inches higher than the topmost point of the equipment being screened.
- 2) Access gates must be provided on the fourth side and must also be at least height 6 inches higher than the topmost point of the equipment being screened.
- 3) Any screening used must meet *17.65.50.H.3, Wall/Fence Design and Installation*.

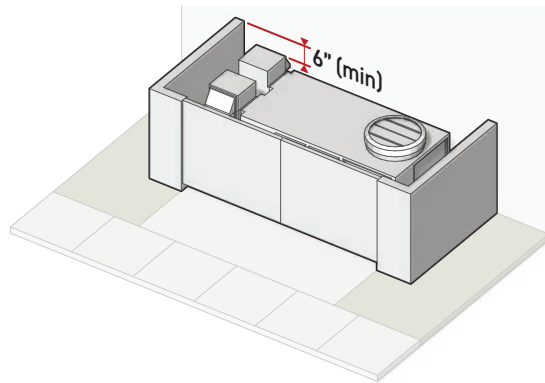



## F. Wall-Mounted Equipment Screening

### 1. Applicability

All outdoor mechanical or utility equipment attached to the wall of a building or structure must meet the following screening standards.

### 2. Standards

#### a. Location

Wall-mounted outdoor mechanical or utility equipment cannot be attached to a building facade facing a front lot line unless it is screened meeting the standards below.

#### b. Screening Enclosure

1) Equipment must be screened by solid wall or fence that is at least height 6 inches higher than the topmost point of the equipment being screened.

2) Any screening used must meet *17.65.50.H.3, Wall/Fence Design and Installation*.

## G. Outdoor Storage Screening

### 1. Applicability

Where material or equipment is stored outside of a completely enclosed building.

### 2. Defined

a. The outdoor storage of in crates, on pallets or in shipping containers;

b. The outdoor storage of contractors' equipment;

c. The outdoor storage of vehicles, boats, recreational vehicles, trailers or other similar vehicles.

d. The overnight outdoor storage of vehicles awaiting repair; and

e. The outdoor storage of soil, mulch, stone, lumber, pipe, steel, salvage or recycled materials, and other similar merchandise, material or equipment.

### 3. Standards

Where allowed, outdoor storage may not be more than 10 feet in height and must be fully screened from view from the public right-of-way by a Type B4 frontage screen, see *17.65.50.B, Frontage Screens*.

# H. Walls and Fences

## 1. Front Yards

### a. Applicability

- 1) All non-required walls and fences in a front yard.
- 2) Where a frontage screen includes a wall or fence, the required screen standards supersede the front yard wall and fence standards.

### b. Front Yard Fence and Wall Standards

#### Type C1

Intended for front yards where buildings engage directly with the public realm to provide natural surveillance and visual interest along the public realm. Especially where ground floor uses are commercial.

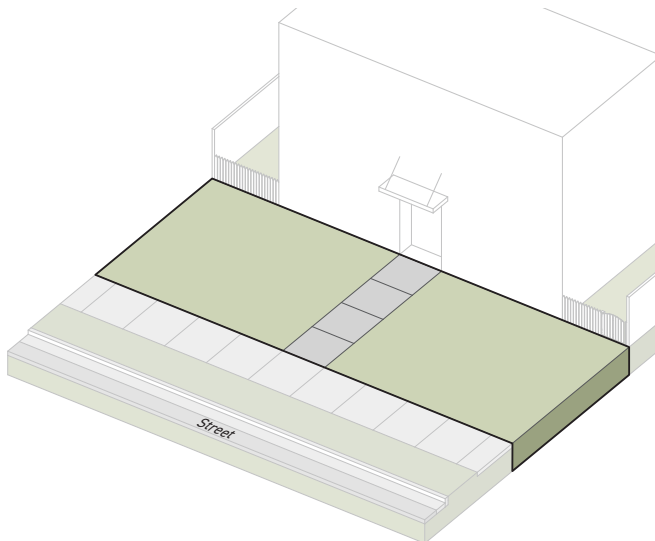

DIMENSIONAL STANDARDS	
Wall/fence height*	Not allowed

\* A fence or wall a maximum of 42" in height is if required for outdoor consumption of alcohol.

#### Type C2

Intended for front yards where the need for natural surveillance, and visual interest along the public realm is balanced with the need for separation between private ground floor uses and the public realm.

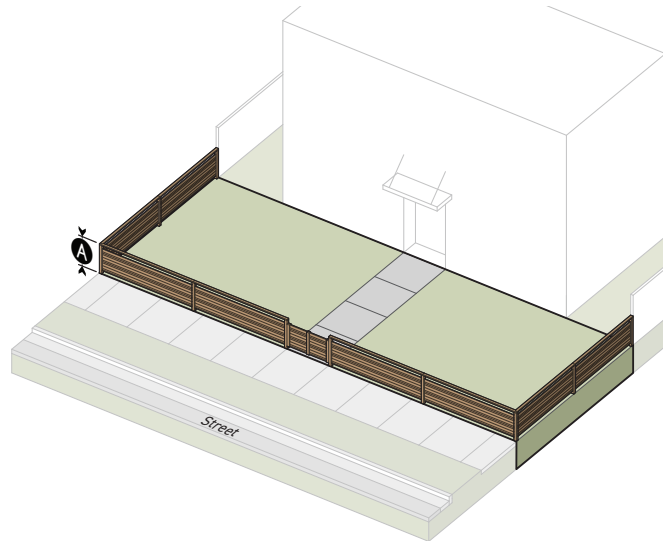

DIMENSIONAL STANDARDS	
Ⓐ Wall/fence height (max)	3.5'

## Type C3

Intended for front yards where the need for natural surveillance and visual interest along the public realm is balanced with the need for security between private uses and the public realm.

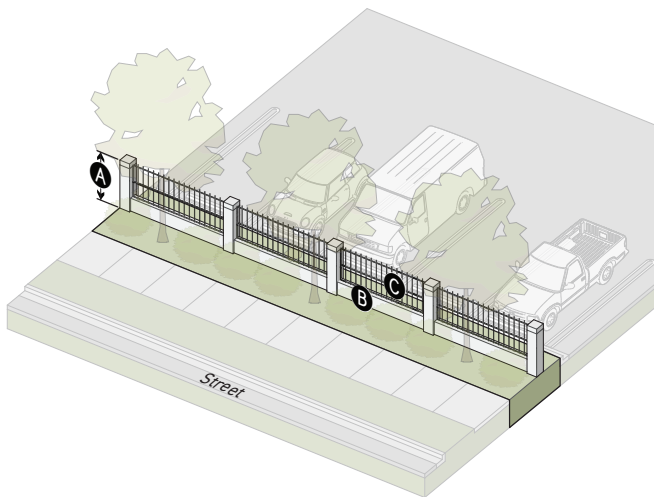

DIMENSIONAL STANDARDS	
<b>A</b>	Wall/fence
	Height (max) 6'
<b>B</b>	Opacity below 3.5' in height (max) 100%
<b>C</b>	Opacity 3.5' and above in height (max) 50%

In the Arterial Frontage, the wall/fence type is not allowed between the building and street -

## 2. Side/Rear Yards

### a. Applicability

- 1) All non-required walls and fences in a side or rear yard.
- 2) Where a transition screen includes a wall or fence, the required screening standards supersede the side or rear yard wall and fence standards.

### b. Standards

- 1) A wall or fence in the Maker District can be no higher than 10 feet.
- 2) In all other districts, the maximum height is 6 feet.

## 3. Wall/Fence Design and Installation

### a. Applicability

All walls and fences on a lot including walls and fences in a required screen or transition area.

### b. Fence & Wall Height

#### 1) Front Yards

- a) Wall or fence height is measured from the adjacent sidewalk to the topmost point of the wall or fence.

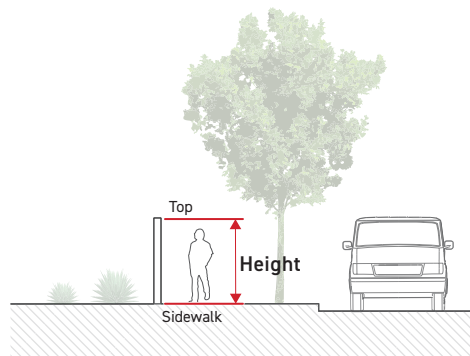

- b) Where no sidewalk exists within 20 feet of the wall or fence, height is measured from at the base of the wall or fence, or hedge to the topmost point of the wall or fence.

## 2) Side/Rear Yards

- a) Where the difference in grade on either side of a wall or fence is less than 2 feet, height is measured from at the base of the wall or fence on the side with the highest grade.

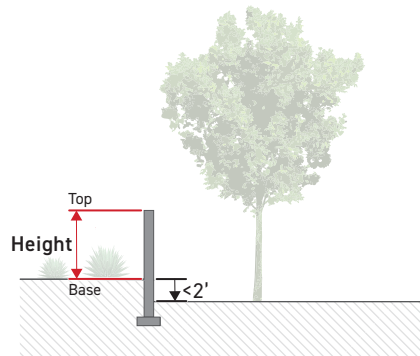

- b) When a wall or fence is located within 3 feet of the exterior face of a retaining wall and the retaining wall is 2 feet in height or greater, height is measured from the top of the wall or fence to the midpoint of the retaining wall.

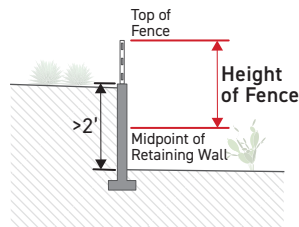

- c) Fences and walls located in a rear or side yard abutting an alley are measured from the surface of the adjacent alley, vertically to the topmost point of the wall or fence.

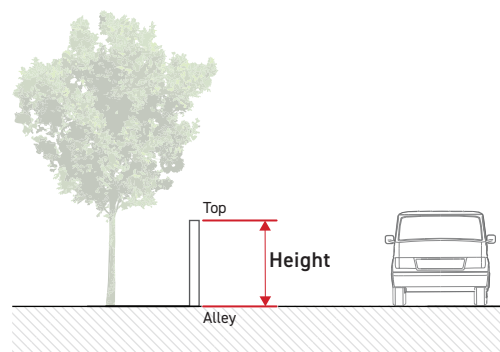

#### 4. **Materials**

- a. Walls and fences must be constructed of a durable, low maintenance material that has a long life expectancy.
- b. No wall or fence may be constructed of tires, junk, or other discarded materials.
- c. Chain-link fence, barbed wire or concertina wire is not allowed.
- d. A wall or fence in a transition area or used as a required screen, must be opaque.

#### 5. **Location**

- a. No wall or fence is allowed within any required drainage or utility easement.
- b. All walls and fences including their sub-grade elements, such as footings or foundation, must be located on-site.
- c. No wall or fence can interfere with visibility at intersections and driveways.

#### 6. **Maintenance**

All walls and fences must be maintained in good repair and must be kept vertical, structurally sound and protected from deterioration.

# I. Plant Material

## 1. Applicability

All plants used to meet a requirement of this Code must meet the following.

## 2. General Provisions

- a. Plants cannot interfere with visibility at intersections and driveways.
- b. Plants must be able to survive on natural rainfall once established with no loss of health.
- c. No artificial plants, trees, or other vegetation may be installed as required landscape.
- d. Plants must be installed for full root contact with the surrounding subgrade. Planters planted on paved surfaces are not permitted.

## 3. Trees

- a. All trees must be in a minimum 24-inch box container size and be a minimum caliper of 1.5 inches at time of planting.
- b. Large trees must have a minimum canopy spread at maturity of 30 feet.
- c. Small trees must have a minimum canopy spread at maturity of 15 feet but no greater than 30 feet.

## 4. Screening Plants

- a. Screening plants must be a minimum height of 1.5 feet at time of planting.
- b. Screening plants must be perennial including, shrubs, grasses and ferns.
- c. Screening plants must have a minimum height at maturity of 3 feet.

## 5. Transition Shrubs

- a. 75% of all shrubs planted to meet a transition requirement must be evergreen and be of a species that must have a minimum height and spread at maturity of 4 feet.
- b. All shrubs planted to meet a transition requirement must be a minimum of 2 feet tall at time of planting.

# 17.65.60. APPROVAL PROCESS

## A. Land Development Project

### 1. Purpose

The purpose of the land development project, as established by state statute, is to review proposed developments to determine compliance with the standards and intent of this Code and pursuant to Rhode Island General Laws §45-23.

### 2. Authority

The Planning Board may approve a land development project. The Planning Board may also approve modifications to select dimensional standards as listed in *17.65.60.A.6*. No demolition, foundation, or building permits will be issued, and no site work will be allowed for any development requiring approval.

### 3. Applicability

Any development that meets one or more of the following criteria is considered a land development project:

- a. New construction of 10,000 square feet or more in gross square footage.
- b. Additions or enlargements to structures where the new gross square footage of the addition or enlargement is 10,000 square feet or more.
- c. Construction of gross square footage that creates 10 or more dwelling or rooming units.
- d. Development of 50 or more new parking spaces.

### 4. Procedure

Given the City's concern regarding execution of the goals of the North End Urban Plan, uses and development requiring a special use permit or a variance shall be classified as a Land Development and shall be reviewed and decided by the Planning Board pursuant to Unified Development Review.



## 5. Guidelines and Standards for Review

Prior to granting approval or issuing findings or recommendations concerning approval, the Planning Board shall find that:

- a. The plans for the development are consistent with the Comprehensive Plan.
- b. The plans for the development are consistent with the North End Urban Plan.
- c. The plans for the development comply with the requirements of the zoning ordinance and subdivision regulations, Titles 12, 13 and 15 of the Codified Ordinances of the City of Newport governing public services, streets, sidewalks and public places, parking, buildings and construction as well as laws, ordinances, rules and regulations governing stormwater management.
- d. The plans for the development are consistent with the requirements of this Code, except as modified in 17.65.60.A.6.
- e. Conditions, restrictions or required site improvements required to meet these guidelines are incorporated in the written approval or guidelines.

## 6. Minor Code Modifications

- a. During the review process, the Planning Board is authorized to approve the following minor code modifications at the request of an applicant.

### 1) Form

<b>BLOCKS</b>	
Perimeter	+50'
Length	+25'
<b>STREETS</b>	
Village Core Street spacing	+50'
Bicycle street spacing	+100'
<b>FRONTAGE</b>	
Active Core percentage	-3%
<b>OPEN SPACE</b>	
Any dimensional requirement (not minimum required amount)	±10%
<b>LOT</b>	
Width	-1'
<b>BUILDING SETBACKS</b>	
Side or rear line setback	-1'
<b>TRANSITIONS</b>	
Any dimensional requirement	±10%

<b>BUILDING</b>	
Maximum building height in feet	+5'
Minimum building height	+5'
Building width	+10%

## 2) Frontage

<b>BUILD-TO</b>	
Front line setback	-1'
Depth	+2'
Width	-10%
Occupiable depth	-3'
<b>STREETSCAPE</b>	
Any dimensional requirement	-10%
<b>STORY HEIGHT</b>	
Any dimensional requirement	±10%
<b>TRANSPARENCY</b>	
Ground-/upper-story transparency requirement	-10%
Blank wall width	+5'
<b>PEDESTRIAN ACCESS</b>	
Street-facing entrance spacing	+10%
Any dimensional requirement	±10%
<b>VEHICLE ACCESS</b>	
Any dimensional requirement	±10%

## 3) Parking and Loading

<b>BICYCLE PARKING</b>	
Required spaces	-10%
Bicycle facilities dimensional requirement	-10%
<b>AUTOMOBILE PARKING</b>	
Maximum parking	+15%
Reserved parking	+10%
Parking space/lot dimensional requirement	-10%

#### 4) Landscape and Screening

<b>FRONTAGE SCREENS</b>	
Any dimensional requirement	-10%
<b>WALLS AND FENCES</b>	
Any dimensional requirement	±10%
<b>PLANT MATERIAL</b>	
Any dimensional requirement	±10%

- b. During the review process, the Planning Board is also authorized to do the following:
- 1) Where the block perimeter standard cannot be met because of steep slopes in excess of 25%, highways, waterways, railroad lines, conservation areas or major utility easements would make the provision of a conforming block infeasible, the Planning Board may waive the requirement, see *17.65.65.20.G.1, Blocks*.
  - 2) Allow additional encroachments into the Door Yard Zone and Furniture Zone, see *17.65.30.1.4, Streetscape*
  - 3) On-site loading is not required unless determined necessary by the Planning Board, see *17.65.40.D, Loading*.
  - 4) Approve alternate driveway locations, see *17.65.30.1.8.a, Driveway Spacing and 17.65.30.1.8.c, Distance From Intersection*.
  - 5) Approve driveway configurations that include 1 travel lane in excess of the maximum number of lanes specified, see *17.65.30.1.8.d, Number of Lanes*.

#### 7. Appeals

An appeal to the Zoning Board of Review may be taken by an aggrieved party from the decision of Planning Board, see *17.116.010*.

## 17.65.70. DEFINITIONS

The following terms are defined for the purpose of this Code. Terms not defined below may be defined in *17.08.010. - Definitions*. In such case, the definition contained in *17.08.010* should be used. If there is a conflict between a definition in *17.08.010* and this Code, the definition in this Code must be used.

**Advanced Manufacturing** - is the use of best practices technology to improve products or processes, often integrating new technologies in both products and processes.

**Automobile** - A motor vehicle that typically has no more than four wheels.

**Average Sidewalk Grade** -

**Co-Working Space** - a facility where people assemble in a neutral space to work independently on different projects, or in groups on the same projects. It's different than a typical office because people in a co-working space generally aren't working for the same company.

**Cultural institution** - a public or nonprofit institution that engages in the cultural, intellectual, scientific, environmental, educational or artistic enrichment of the people.

**Drive-Thru Facility** - A facility that provides a service directly to a automobile or where the customer drives a automobile onto the premise and to a window or mechanical device through or by which the customer is serviced without exiting the vehicle.

**Driveway Lane** - All areas designed and designated for motor vehicles to move between a street right-of-way and a lot.

**Finished Grade** - the elevation of the ground surface after completion of all work.

**Live-Work Dwelling** - a single unit consisting of both a commercial/office and a residential component that is occupied by the same resident.

**Grade** - the elevation or contour of the ground surface of a site.

**Maker Space** - a facility focused on technology and small-scale manufacturing opportunities, such as making furniture, clothing, watches, jewelry or bicycles, but also including uses such as a catering facility, coffee roasting, glass blowing, metal/ art fabrication, welding, small machine shop, wholesale bakery or a pottery-making facility.

**Mezzanine** - an open area set above other spaces in room - see the Building Code for specifications.

**Motor Vehicle** - A self-propelled devise designed for transporting persons or property with the ability to reach speeds over 20 miles per hour.

**Motor Vehicle Use Area** - An area designed and intended for use by motor vehicles.

**Multi-Modal Transportation Facility** - a facility that accommodates a variety of transit modes and services including local and regional bus service.

**Occupiable Space** - Area covered by a roof that is designed and intended for human occupancy.

**Opacity** - measured as a percentage, calculated by dividing the solid portion of the object area by the total area of the object. The total area of the object is measured as the smallest regular shape containing all elements of the object or assembly.

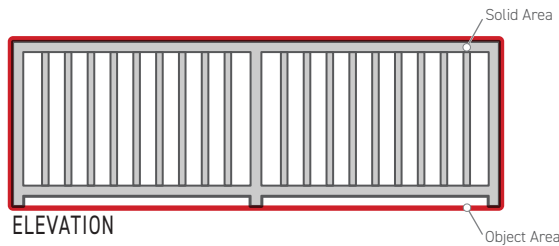

**FORMULA**

$$\frac{\text{Solid Area}}{\text{Object Area}} = \text{Opacity (\%)}$$

**Ordinary maintenance and repair** - work where the purpose and effect of such work is to correct any deterioration of or damage to a building, structure or site element to restore the same, as nearly as may be practicable, to its condition prior to the occurrence of such deterioration or damage.

**Street Stub** - a temporary street ending that is intended to be extended through adjacent property in the future.

**Yard** - the area between the building and any lot line, including a front yard, side yard or rear yard

Front Yard - the full width of a lot that is located between a front lot line and the principal building. Does not include any building facade set back at least 20 feet from the principal building's street-facing facade.

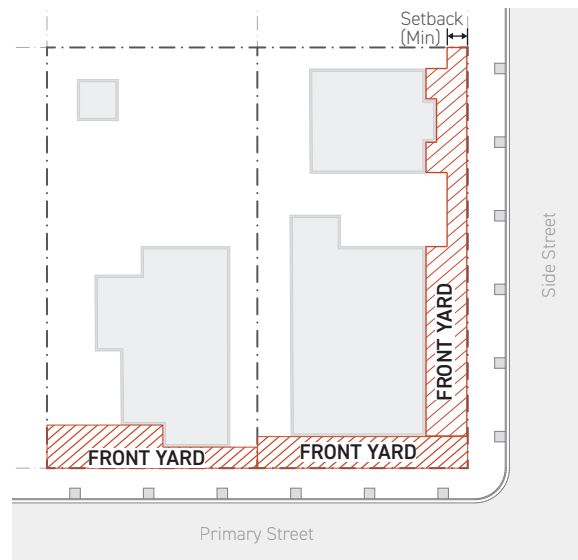

Rear Yard - includes the full width of a lot that is located between a rear lot line and the principal building. A rear yard does not include any building facade set back at least 20 feet from the principal building's rear facade.

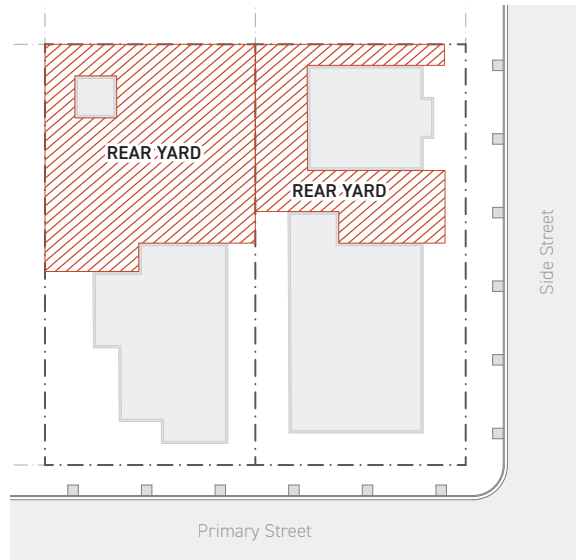

Side Yard - the remaining portions of a lot between a side lot line and a principal building.

